

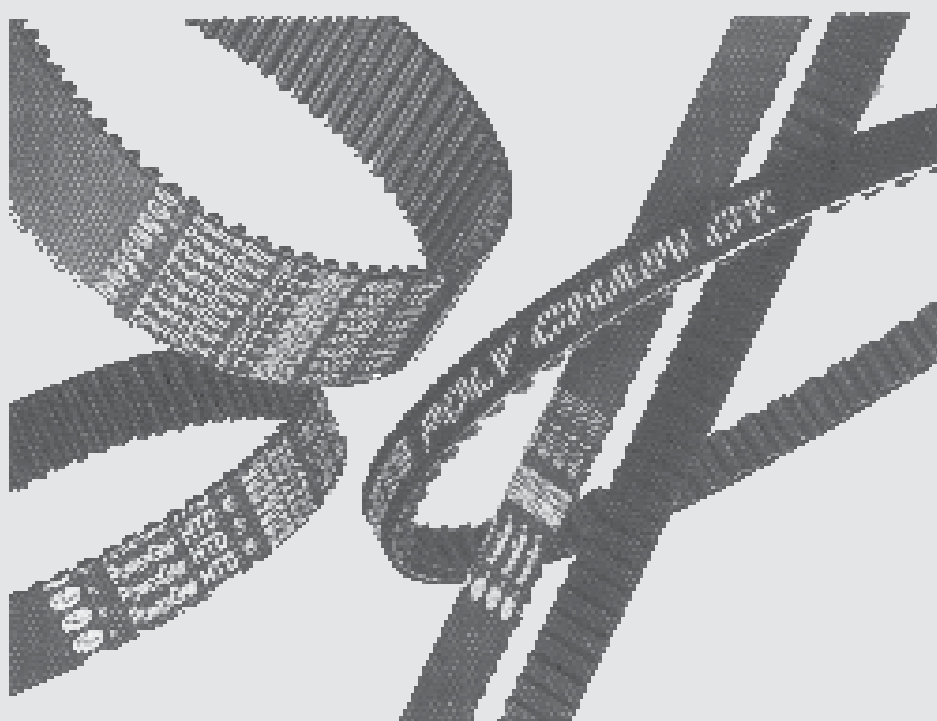

## Pasy zębate









## Rodzaje pasów



Typ		Podział.	Całkowita wys.	Wys. zęba
PowerGrip® GT (3) 	<b>2MGT</b>	2	1.52	0.71
	<b>3MGT</b>	3	2.41	1.12
	<b>5MGT</b>	5	3.81	1.91
	<b>8MGT</b>	8	5.60	3.40
	<b>14MGT</b>	14	10.00	6.00

Typ		Podział.	Całkowita wys.	Wys. zęba
Poly Chain® GT (2) 	<b>8MGT</b>	8	5.9	3.4
	<b>14MGT</b>	14	10.2	6.0

Typ		Podział.	Całkowita wys.	Wys. zęba
PowerGrip® HTD® 	<b>3M</b>	3	2.41	1.17
	<b>5M</b>	5	3.81	2.08
	<b>8M</b>	8	6.00	3.40
	<b>14M</b>	14	10.00	6.00
	<b>20M</b>	20	13.20	8.40

Typ		Podział.	Całkowita wys.	Wys. zęba
Synchro-Power® 	<b>AT 5</b>	5	2.70	1.20
	<b>AT10</b>	10	5.00	2.50
Synchro-Power® 	<b>T 2.5</b>	2.5	1.30	0.70
	<b>T 5</b>	5.0	2.20	1.20
	<b>T10</b>	10.0	4.50	2.50

Typ		Podział.	Całkowita wys.	Wys. zęba
RPP 	<b>RPP 5</b>	5	3.80	2.00
	<b>RPP 8</b>	8	5.40	3.20
	<b>RPP 14</b>	14	10.00	6.00

Typ		Podział.	Całkowita wys.	Wys. zęba
Synchro-Power® 	<b>DT 5</b>	5.0	3.40	1.20
	<b>DT10</b>	10.0	7.00	2.50
PowerGrip® 	<b>5MGT</b>	5	5.34	2.10
	<b>8MGT</b>	8	8.27	3.45
	<b>14MGT</b>	14	14.83	6.02
PowerGrip® 	<b>XL</b>	5.080	3.05	1.27
	<b>L</b>	9.525	4.58	1.91
	<b>H</b>	12.700	5.95	2.92

Typ		Podział.	Całkowita wys.	Wys. zęba
PowerGrip® 	<b>MXL</b>	2.032	1.14	0.51
	<b>XL</b>	5.080	2.30	1.27
	<b>L</b>	9.525	3.50	1.91
	<b>H</b>	12.700	4.00	2.29
	<b>XH</b>	22.225	11.40	6.35
	<b>XXH</b>	31.750	15.20	9.53

Rozmiary w mm.

## Pasy zębate

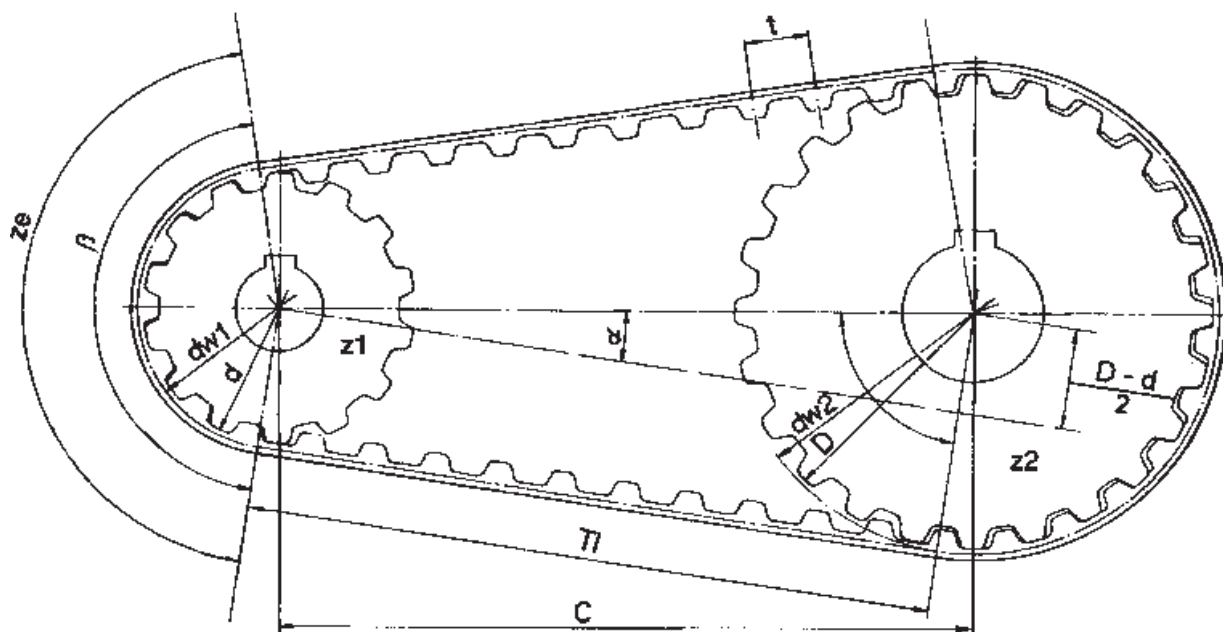

Rzeczywista średnica koła małego:	dw1	Odległość międzyosiwa:	C
Rzeczywista średnica koła dużego:	dw2	Ilość zębów w opasaniu:	ze
Ilość zębów koła małego:	z1	Wolna odległość:	Tl
Ilość zębów koła dużego:	z2	Podziałka:	t
Wewnętrzna średnica koła małego:	d	Kąt opasania:	$\beta$
Wewnętrzna średnica koła dużego:	D		



Tabela obliczeniowa

Rzeczywista średnica	$d_w$	$= \frac{z \cdot t}{\pi}$
Przełożenie	$i$	$= \frac{n_{\text{napędzający}}}{n_{\text{napędzany}}} = \frac{z_1}{z_2} = \frac{z_1}{d}$
Kąt opasania	$\beta$	$= 2 \cdot \arccos \left[ \frac{D - d}{2C} \right]$
Ilość zębów w opasaniu	$z_e$	$= z_1 \frac{\beta}{360}$
Długość pasa	$L$	$= 2C \sin \frac{\beta}{2} + \frac{\pi}{2} \left[ D + d + \left( 1 - \frac{\beta}{180} \right) (D - d) \right]$ dla $i = 1$ : $\beta = 180^\circ$ , $\sin \frac{\beta}{2} = 1$ , $D = d$ pak $L = 2C + \pi D$
Odległość pomiędzy osiami	$C$	$= \frac{1}{2} \cdot \frac{1}{\sin \frac{\beta}{2}} \left( L - \frac{\pi}{2} \left[ (D + d) + \left( 1 - \frac{\beta}{180} \right) (D - d) \right] \right)$ dla $i = 1$ : $\beta = 180^\circ$ , $\sin \frac{\beta}{2} = 1$ , $D = d$ pak $C = \frac{1}{2} (L - \pi D)$
Teoretyczna długość pasa	$L$	$\approx 2C + \frac{\pi}{2} (D + d) + \frac{(D - d)^2}{4C}$
Moment obrotowy	$M$	$= \frac{d_w \cdot F_u}{2 \cdot 10^3} = \frac{9.55 \cdot 10^3 \cdot P}{n} = \frac{d_w \cdot P}{2 \cdot v}$
Siła obwodowa	$F_u$	$= \frac{2 \cdot 10^3 \cdot M}{d_w} = \frac{19.1 \cdot 10^6 \cdot P}{n \cdot d_w} = \frac{10^3 \cdot P}{v}$
Moc	$P$	$= \frac{M \cdot n}{9.55 \cdot 10^3} = \frac{F_u \cdot d_w \cdot n}{19.1 \cdot 10^6} = \frac{F_u \cdot v}{10^3}$
Ilość obrotów	$n$	$= \frac{19.1 \cdot 10^3 \cdot v}{d_w}$
Prędkość obwodowa	$v$	$= \frac{d_w \cdot n}{19.1 \cdot 10^3}$

Siła 1 kp = 1 kg • 9.81 m/s<sup>2</sup> = 9.81 N ≈ 1 daN

Moment obrotowy 1 kpm = 9.81 kgm<sup>2</sup>/s<sup>2</sup> = 9.81 Nm ≈ 1 daNm

Moc 1 PS = 75 kpm/s = 0.736 kW

Moment rozprędu 1 [GD<sup>2</sup>] = 4 [J] przy GD<sup>2</sup> w kpm<sup>2</sup> i J w kgm<sup>2</sup>

Zdalny napęd wg specyfikacji można uzyskać za pomocą programu komputerowego, w tym przypadku prosimy kontaktować się ze specjalistami z firmy HABERKORN ULMER POLSKA.



## Zalecane minimalne rozmiary kół zębatych:



Typ		Podziałka w mm	Ilość zębów z	Zalecany minimalny wymiar	
				mm	Cal
PowerGrip®	MXL	2.032	10	6.47	0.254
	XL	5.080	10	16.17	0.637
	L	9.525	10	30.32	1.19
	H	12.700	14	56.60	2.23
	XH	22.225	18	127.34	5.01
	XXH	31.750	18	181.91	7.16
PowerGrip® HTD®	3M	3	10	9.55	0.37
	5M	5	14	22.38	0.88
	8M	8	22	56.02	2.21
	14M	14	28	124.78	4.91
	20M	20	34	216.45	8.52
PowerGrip® GT3	2MGT	2	10	6.36	0.25
	3MGT	3	16	15.28	0.60
	5MGT	5	18	28.65	1.13
	8MGT	8	22	56.02	2.21
	14MGT	14	28	124.78	4.91
Poly Chain® GT2	8MGT	8	22	56.02	2.21
	14MGT	14	28	124.78	4.91
Synchro- Power®	T 2.5	2.5	10	7.96	3.13
	T 5	5	10	15.92	0.63
	T10	10	12	38.20	1.50
	RPP 5	5	12	19.11	0.75
	RPP 8	8	18	45.86	1.81
	RPP 14	14	32	142.68	5.62

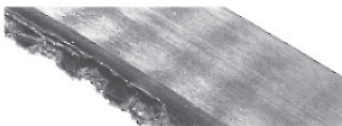

## Tabela problemów i ich rozwiązywanie:

Problem	Możliwe przyczyny	Sposób usuwania
Podwyższony hałas	<ol style="list-style-type: none"> <li>1. Nieosiowy napęd</li> <li>2. Za słabo lub za mocno napięty pas</li> <li>3. Zewnętrzny napinacz</li> <li>4. Zużyte koło zębate</li> <li>5. Odpadnięty ogranicznik boczny</li> <li>6. Szybkość pasa jest za wysoka</li> <li>7. Zły profil pasa do zębów koła</li> <li>8. Za mała średnica koła</li> <li>9. Niedopasowane obciążenie</li> </ol>	<ol style="list-style-type: none"> <li>1. Ustawić osiowość</li> <li>2. Odpowiednio naprężyć pas</li> <li>3. Zastosować wewnętrzny napinacz</li> <li>4. Wymienić koło zębate</li> <li>5. Zamocować ogranicznik</li> <li>6. Obliczyć nowy napęd</li> <li>7. Zastosować odpowiednią kombinację pasa i koła</li> <li>8. Obliczyć nowy napęd z większymi kołami</li> <li>9. Obliczyć większy nowy napęd</li> </ol>
Utrata napięcia pasa	<ol style="list-style-type: none"> <li>1. Słaba konstrukcja nośna</li> <li>2. Przedwczesne zużycie zębów koła</li> <li>3. Zbyt wielka osiowa odległość</li> <li>4. Zbyt duże zabrudzenie</li> <li>5. Niedopasowane obciążenie</li> <li>6. Za małe średnice kół</li> <li>7. Pas, koło lub wałek nadmiernie się nagrzewają.</li> <li>8. Pas nadmiernie szybko się niszczy.</li> </ol>	<ol style="list-style-type: none"> <li>1. Wzmocnić konstrukcję nośną</li> <li>2. Wymienić zużyte koło</li> <li>3. Zastosować wewnętrzny napinacz</li> <li>4. Nieczystości usunąć, zastosować obudowy ochronne</li> <li>5. Obliczyć mocniejszy napęd</li> <li>6. Zastosować większe koła</li> <li>7. Zastosować odbiornik ciepła z napędu</li> <li>8. Obniżyć temperaturę do 85°C</li> </ol>
Nadmierne zużycie boków pasa 	<ol style="list-style-type: none"> <li>1. Uszkodzenie przy obsłudze</li> <li>2. Uszkodzone ograniczniki koła</li> <li>3. Pasy są za szerokie</li> <li>4. Pas jest za słabo napięty</li> <li>5. Chropowata powierzchnia ogranicznika</li> <li>6. Pas pracuje nierównomiernie</li> <li>7. Pasy dotykają obudowy napędu</li> </ol>	<ol style="list-style-type: none"> <li>1. Przeszkolić odpowiednio personel</li> <li>2. Wymienić ograniczniki lub koło</li> <li>3. Zastosować odpowiednie pasy</li> <li>4. Napiąć odpowiednio mocno pas</li> <li>5. Wyszlifować ograniczniki</li> <li>6. Sprawdzić osiowość napędu</li> <li>7. Dostosować obudowę lub zastosować zewnętrzny napinacz</li> </ol>

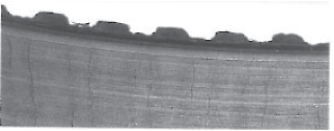

Problem	Możliwe przyczyny	Sposób usuwania
<p>Przetarte włókna pasa</p> 	<ol style="list-style-type: none"> <li>1. Zbyt duże obciążenie</li> <li>2. Zbyt mała średnica kół</li> <li>3. Źle zamontowany pasek</li> <li>4. Nieczystości lub ciała obce w napędzie</li> <li>5. Zużyte nadmiernie koła pasowe</li> <li>6. Złe magazynowanie</li> </ol>	<ol style="list-style-type: none"> <li>1. Zastosować mocniejszy napęd</li> <li>2. Zastosować napęd z większymi kołami</li> <li>3. Stosować się do zaleceń producenta</li> <li>4. Wyczyścić, zastosować osłony</li> <li>5. Wymienić koła</li> <li>6. Nie układać na kołach innych przedmiotów</li> </ol>
<p>Tworzenie się szczelin na pasie</p> 	<ol style="list-style-type: none"> <li>1. Zbyt mała średnica kół</li> <li>2. Zewnętrzny napinacz</li> <li>3. Ekstremalnie niska temperatura</li> <li>4. Agresywne chemikalia w styczności z napędem</li> <li>5. Wkładka/koło montowane</li> </ol>	<ol style="list-style-type: none"> <li>1. Zastosować napęd z większymi kołami</li> <li>2. Zwiększyć średnice napinacza lub zastosować napinacz wewnętrzny</li> <li>3. Podgrzewać okolice napędu</li> <li>4. Obudować napęd</li> <li>5. Przy montażu pas nie może być</li> </ol>
<p>Przedwczesne zużycie zębów</p> 	<ol style="list-style-type: none"> <li>1. Zbyt niskie lub zbyt mocne napięcie pasa</li> <li>2. Pas pracuje na źle zamocowanym kole</li> <li>3. Nieosiowy napęd</li> <li>4. Zły profil pasa w stosunku do koła</li> <li>5. Zużyte koło pasowe</li> <li>6. Uszkodzone zęby koła</li> <li>7. Postopniowane zęby koła</li> <li>8. Koło nie jest wykonane wg żądanej specyfikacji</li> <li>9. Pas dotyka obudowy napędu</li> <li>10. Zbyt duże obciążenie</li> <li>11. Zbyt miękki materiał zastosowany do produkcji koła</li> <li>12. Nadmierne nieczystości</li> <li>13. Ekscentrycznie montowana wkładka koła</li> </ol>	<ol style="list-style-type: none"> <li>1. Sprawnie napiąć pas</li> <li>2. Zamocować koło</li> <li>3. Ustawić osiowość</li> <li>4. Zastosować odpowiednią kombinację pasa i kół napędu</li> <li>5. Wymienić koło na nowe</li> <li>6. Wymienić koło na nowe</li> <li>7. Wymienić koło na nowe</li> <li>8. Wymienić koło na nowe</li> <li>9. Dostosować odpowiednio obudowę napędu</li> <li>10. Zastosować mocniejszy napęd</li> <li>11. Zastosować koło o odpowiedniej twardości</li> <li>12. Usunąć nieczystości, zastosować obudowy ochronne</li> <li>13. Wkładki montować wg wskazówek</li> </ol>

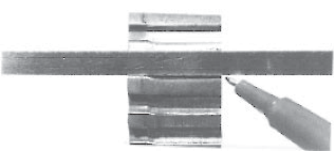

Problem	Możliwe przyczyny	Możliwe rozwiązania
<p>Zęby wytarte</p> 	<ol style="list-style-type: none"> <li>1. Za duże uderzenie przy starcie</li> <li>2. Mniej niż 6 zębów na napędzie</li> <li>3. Zęby koła są wyrobione poniżej dopuszczalnej tolerancji</li> <li>4. Zużyte koło zębate</li> <li>5. Zewnętrzny napinacz</li> <li>6. Zły profil pasa do zębów koła</li> <li>7. Nieosiowy napęd</li> <li>8. Żle napięty pas</li> </ol>	<ol style="list-style-type: none"> <li>1. Zastosować większy napęd</li> <li>2. Zastosować nowy napęd</li> <li>3. Wymenić koło zębate</li> <li>4. Wymenić koło zębate</li> <li>5. Zastosować wewnętrzny napinacz</li> <li>6. Zastosować odpowiednią kombinację pasa i koła</li> <li>7. Ustawić osiowość</li> <li>8. Odpowiednio napiąć pas</li> </ol>
<b>Problemy kół zębatach</b>		
Wypadają ograniczenia boczne	1. Pas wybija ograniczniki	1. Sprawdzić osiowość całego napędu
<p>Zbyt szybkie zużywanie</p> 	<ol style="list-style-type: none"> <li>1. Koło jest z materiału mało odpornego na ścieranie (plastik, aluminium)</li> <li>2. Nieosiowy napęd</li> <li>3. Nieczystości</li> <li>4. Za duże uderzenie przy starcie</li> <li>5. Za mało lub za mocno napięty pas</li> <li>6. Zły profil pasa do zębów koła</li> </ol>	<ol style="list-style-type: none"> <li>1. Zastosować koło zębate z innego materiału</li> <li>2. Ustawić osiowość</li> <li>3. Usunąć nieczystości, zastosować ochronne obudowy</li> <li>1. Zastosować większy napęd</li> <li>5. Odpowiednio naprężyć pas</li> <li>6. Zastosować odpowiednią kombinację pasa i koła</li> </ol>
<b>Problem z synchronicznym pasem</b>		
Pas zębata pracuje nierównomiernie (tracking)	<ol style="list-style-type: none"> <li>1. Pas ześlizguje się z koła</li> <li>2. Odległość osiowa przekracza ośmiokrotnie średnicę małego koła</li> <li>3. Ściera się bok pasa</li> </ol>	<ol style="list-style-type: none"> <li>1. Ustawić osiowość</li> <li>2. Ustawić osiowość i ustawienie pasa na obu kołach</li> <li>3. Ustawić osiowość</li> </ol>
Niestabilna temperatura: pasa, łożyska, wałka, obudowy itd.	<ol style="list-style-type: none"> <li>1. Nieosiowy napęd</li> <li>2. Za mało lub za mocno napięty pas</li> <li>3. Zły profil pasa do zębów koła</li> </ol>	<ol style="list-style-type: none"> <li>1. Ustawić osiowość</li> <li>2. Odpowiednio naprężyć pas</li> <li>3. Zastosować odpowiednią kombinację pasa i koła</li> </ol>
Wałki niemają synchronicznych obrotów	<ol style="list-style-type: none"> <li>1. Złe obliczenie napędu</li> <li>2. Zły pas</li> </ol>	<ol style="list-style-type: none"> <li>1. Obliczyć nowy napęd</li> <li>2. Założyć odpowiedni pas</li> </ol>
Wibracje - zachwiania	<ol style="list-style-type: none"> <li>1. Zły profil pasa do zębów koła</li> <li>2. Za mało lub za mocno napięty pas</li> <li>3. Tuleja mocująca lub kliniek są luźne</li> </ol>	<ol style="list-style-type: none"> <li>1. Zastosować odpowiednią kombinację pasa i koła</li> <li>2. Odpowiednio napiąć pas</li> <li>3. Skontrolować rozmiary i na nowo zamontować</li> </ol>





## Pasy zębate z poliuretanu

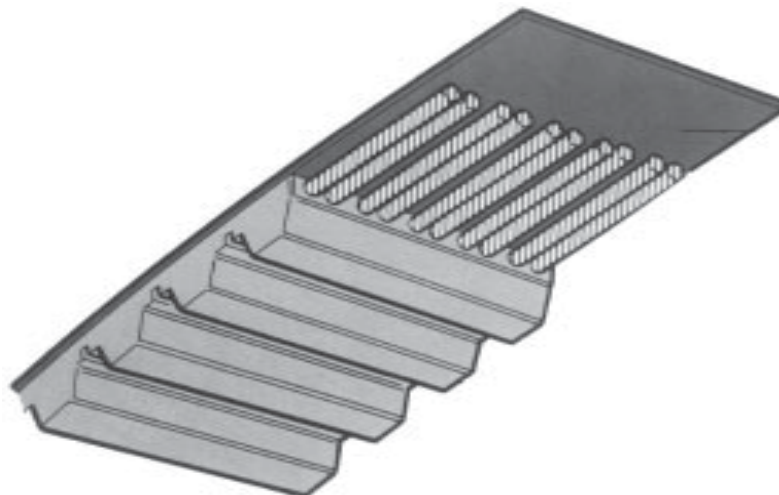

Poliuretanowe pasy zębate są produkowane w technologii termoutwardzalnej. Wysoko jakościowy poliuretan odporny jest na tarcie. W powiązaniu ze stalowym kordem otrzymujemy bardzo dobrej jakości pasy, zapewniające wysoką wytrzymałość.

Pasy te mają następującą charakterystykę:

### Charakterystyka pasów:

- stałość wymiarów, stabilność wymiarów
- niskie sprężanie
- niski poziom hałasu
- wysoka odporność na ścieranie
- bezobsługowość
- prędkość liniowa aż do 80 m/sec

### Chemiczna charakterystyka:

- dobra odporność na:
  - starzenie
  - hydrolizę
  - UVA
  - ozon
- temperatura pracy w przedziale – 30°C + 80°C (chwilowo do +110°C)
- wysoka odporność na oleje, smary
- dobra odporność na większość kwasów i zasad

# Pas zębaty T 2.5

Podziałka 2.5 mm

Materiał

Poliuretan

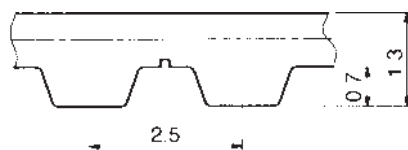

## Szerokość pasa 4 mm

Kod	Oznaczenie	Ilość zębów z	Długość mm	Kod	Oznaczenie	Ilość zębów z	Długość mm
T 22225	4 T2.5 - 120	48	120.0	T 22238	4 T2.5 - 420	168	420.0
T 22226	4 T2.5 - 145	58	145.0	T 22239	4 T2.5 - 480	192	480.0
T 22227	4 T2.5 - 160	64	160.0	T 22241	4 T2.5 - 500	200	500.0
T 22228	4 T2.5 - 177.5	71	177.5	T 22242	4 T2.5 - 600	240	600.0
T 22229	4 T2.5 - 200	80	200.0	T 22243	4 T2.5 - 620	248	620.0
T 22230	4 T2.5 - 230	92	230.0	T 22244	4 T2.5 - 650	260	650.0
T 22231	4 T2.5 - 245	98	245.0	T 41661	4 T2.5 - 680	272	680.0
T 22232	4 T2.5 - 265	106	265.0	T 22245	4 T2.5 - 780	312	780.0
T 22233	4 T2.5 - 285	114	285.0	T 41663	4 T2.5 - 880	352	880.0
T 22234	4 T2.5 - 305	122	305.0	T 22246	4 T2.5 - 915	366	915.0
T 22235	4 T2.5 - 317.5	127	317.5	T 22247	4 T2.5 - 950	380	950.0
T 22236	4 T2.5 - 330	132	330.0	T 41665	4 T2.5 - 1185	474	1185.0
T 22237	4 T2.5 - 380	152	380.0				

## Szerokość pasa 6 mm

T 22248	6 T2.5 - 120	48	120.0	T 22261	6 T2.5 - 420	168	420.0
T 22249	6 T2.5 - 145	58	145.0	T 22262	6 T2.5 - 480	192	480.0
T 22250	6 T2.5 - 160	64	160.0	T 22264	6 T2.5 - 500	200	500.0
T 22251	6 T2.5 - 177.5	71	177.5	T 22265	6 T2.5 - 600	240	600.0
T 22252	6 T2.5 - 200	80	200.0	T 22266	6 T2.5 - 620	248	620.0
T 22253	6 T2.5 - 230	92	230.0	T 22267	6 T2.5 - 650	260	650.0
T 22254	6 T2.5 - 245	98	245.0	T 41667	6 T2.5 - 680	272	680.0
T 22255	6 T2.5 - 265	106	265.0	T 22268	6 T2.5 - 780	312	780.0
T 22256	6 T2.5 - 285	114	285.0	T 41669	6 T2.5 - 880	352	880.0
T 22257	6 T2.5 - 305	122	305.0	T 22269	6 T2.5 - 915	366	915.0
T 22258	6 T2.5 - 317.5	127	317.5	T 22270	6 T2.5 - 950	380	950.0
T 22259	6 T2.5 - 330	132	330.0	T 41671	6 T2.5 - 1185	474	1185.0
T 22260	6 T2.5 - 380	152	380.0				

Rozmiary w mm.

### UWAGA:

Koła zębate o szerokości 4 mm na zapytnie, dla szerokości 6 mm patrz strona H 2.

# Pas zębaty T 2.5

Podziałka 2.5 mm

Materiał

Poliuretan

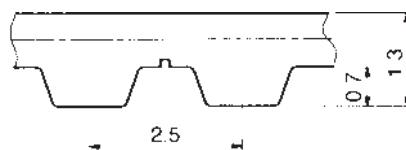

## Szerokość pasa 8 mm

Kod	Oznaczenie	Ilość zębów z	Długość mm	Kod	Oznaczenie	Ilość zębów z	Długość mm
T 22271	8 T2.5 - 120	48	120.0	T 22284	8 T2.5 - 420	168	420.0
T 22272	8 T2.5 - 145	58	145.0	T 22285	8 T2.5 - 480	192	480.0
T 22273	8 T2.5 - 160	64	160.0	T 22287	8 T2.5 - 500	200	500.0
T 22274	8 T2.5 - 177.5	71	177.5	T 22288	8 T2.5 - 600	240	600.0
T 22275	8 T2.5 - 200	80	200.0	T 22289	8 T2.5 - 620	248	620.0
T 22276	8 T2.5 - 230	92	230.0	T 22290	8 T2.5 - 650	260	650.0
T 22277	8 T2.5 - 245	98	245.0	T 41672	8 T2.5 - 680	272	680.0
T 22278	8 T2.5 - 265	106	265.0	T 22291	8 T2.5 - 780	312	780.0
T 22279	8 T2.5 - 285	114	285.0	T 41674	8 T2.5 - 880	352	880.0
T 22280	8 T2.5 - 305	122	305.0	T 22292	8 T2.5 - 915	366	915.0
T 22281	8 T2.5 - 317.5	127	317.5	T 22293	8 T2.5 - 950	380	950.0
T 22282	8 T2.5 - 330	132	330.0	T 41676	8 T2.5 - 1185	474	1185.0
T 22283	8 T2.5 - 380	152	380.0				

## Szerokość pasa 10 mm

T 22294	10 T2.5 - 120	48	120.0	T 22307	10 T2.5 - 420	168	420.0
T 22295	10 T2.5 - 145	58	145.0	T 22308	10 T2.5 - 480	192	480.0
T 22296	10 T2.5 - 160	64	160.0	T 22310	10 T2.5 - 500	200	500.0
T 22297	10 T2.5 - 177.5	71	177.5	T 22311	10 T2.5 - 600	240	600.0
T 22298	10 T2.5 - 200	80	200.0	T 22312	10 T2.5 - 620	248	620.0
T 22299	10 T2.5 - 230	92	230.0	T 22313	10 T2.5 - 650	260	650.0
T 22300	10 T2.5 - 245	98	245.0	T 41678	10 T2.5 - 680	272	680.0
T 22301	10 T2.5 - 265	106	265.0	T 22314	10 T2.5 - 780	312	780.0
T 22302	10 T2.5 - 285	114	285.0	T 41679	10 T2.5 - 880	352	880.0
T 22303	10 T2.5 - 305	122	305.0	T 22315	10 T2.5 - 915	366	915.0
T 22304	10 T2.5 - 317.5	127	317.5	T 22316	10 T2.5 - 950	380	950.0
T 22305	10 T2.5 - 330	132	330.0	T 41680	10 T2.5 - 1185	474	1185.0
T 22306	10 T2.5 - 380	152	380.0				

Rozmiary w mm.

### UWAGA:

Koła zębate na zapytanie.

# Pas zębaty T 2.5

Podziałka 2.5 mm

Materiał

Poliuretan

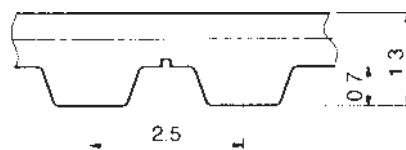

## Szerokość pasa 12 mm

Kod	Oznaczenie	Ilość zębów z	Długość mm	Kod	Oznaczenie	Ilość zębów z	Długość mm
T 22317	12 T2.5 - 120	48	120.0	T 22330	12 T2.5 - 420	168	420.0
T 22318	12 T2.5 - 145	58	145.0	T 22331	12 T2.5 - 480	192	480.0
T 22319	12 T2.5 - 160	64	160.0	T 22333	12 T2.5 - 500	200	500.0
T 22320	12 T2.5 - 177.5	71	177.5	T 22334	12 T2.5 - 600	240	600.0
T 22321	12 T2.5 - 200	80	200.0	T 22335	12 T2.5 - 620	248	620.0
T 22322	12 T2.5 - 230	92	230.0	T 22336	12 T2.5 - 650	260	650.0
T 22323	12 T2.5 - 245	98	245.0	T 41683	12 T2.5 - 680	272	680.0
T 22324	12 T2.5 - 265	106	265.0	T 22337	12 T2.5 - 780	312	780.0
T 22325	12 T2.5 - 285	114	285.0	T 41684	12 T2.5 - 880	352	880.0
T 22326	12 T2.5 - 305	122	305.0	T 22338	12 T2.5 - 915	366	915.0
T 22327	12 T2.5 - 317.5	127	317.5	T 22339	12 T2.5 - 950	380	950.0
T 22328	12 T2.5 - 330	132	330.0	T 41685	12 T2.5 - 1185	474	1185.0
T 22329	12 T2.5 - 380	152	380.0				

## Szerokość pasa 16 mm

T 22340	16 T2.5 - 120	48	120.0	T 22353	16 T2.5 - 420	168	420.0
T 22341	16 T2.5 - 145	58	145.0	T 22354	16 T2.5 - 480	192	480.0
T 22342	16 T2.5 - 160	64	160.0	T 22356	16 T2.5 - 500	200	500.0
T 22343	16 T2.5 - 177.5	71	177.5	T 22357	16 T2.5 - 600	240	600.0
T 22344	16 T2.5 - 200	80	200.0	T 22358	16 T2.5 - 620	248	620.0
T 22345	16 T2.5 - 230	92	230.0	T 22359	16 T2.5 - 650	260	650.0
T 22346	16 T2.5 - 245	98	245.0	T 41687	16 T2.5 - 680	272	680.0
T 22347	16 T2.5 - 265	106	265.0	T 22360	16 T2.5 - 780	312	780.0
T 22348	16 T2.5 - 285	114	285.0	T 41688	16 T2.5 - 880	352	880.0
T 22349	16 T2.5 - 305	122	305.0	T 22361	16 T2.5 - 915	366	915.0
T 22350	16 T2.5 - 317.5	127	317.5	T 22362	16 T2.5 - 950	380	950.0
T 22351	16 T2.5 - 330	132	330.0	T 41690	16 T2.5 - 1185	474	1185.0
T 22352	16 T2.5 - 380	152	380.0				

Rozmiary w mm.

### UWAGA:

Koła zębate na zapytanie.

# Pas zębaty T 5

Podziałka 5 mm

Materiał

Poliuretan

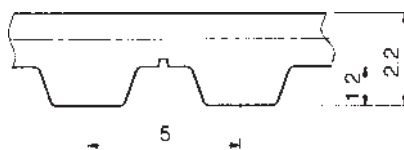

## Szerokość pasa 6 mm

Kod	Oznaczenie	Ilość zębów z	Długość mm	Kod	Oznaczenie	Ilość zębów z	Długość mm
T 64717	6 T5 - 120	24	120.0	T 22398	6 T5 - 550	110	550.0
T 22364	6 T5 - 185	37	185.0	T 22399	6 T5 - 560	112	560.0
T 22365	6 T5 - 200	40	200.0	T 22400	6 T5 - 575	115	575.0
T 49759	6 T5 - 210	42	210.0	T 49711	6 T5 - 590	118	590.0
T 22366	6 T5 - 215	43	215.0	T 22401	6 T5 - 610	122	610.0
T 22367	6 T5 - 220	44	220.0	T 22402	6 T5 - 620	124	620.0
T 22368	6 T5 - 225	45	225.0	T 22403	6 T5 - 630	126	630.0
T 22369	6 T5 - 245	49	245.0	T 22405	6 T5 - 650	130	650.0
T 22370	6 T5 - 250	50	250.0	T 22406	6 T5 - 660	132	660.0
T 22371	6 T5 - 255	51	255.0	T 22407	6 T5 - 690	138	690.0
T 22372	6 T5 - 260	52	260.0	T 22409	6 T5 - 720	144	720.0
T 22373	6 T5 - 270	54	270.0	T 22410	6 T5 - 750	150	750.0
T 22375	6 T5 - 280	56	280.0	T 22411	6 T5 - 780	156	780.0
T 22376	6 T5 - 295	59	295.0	T 22412	6 T5 - 815	163	815.0
T 22378	6 T5 - 305	61	305.0	T 41709	6 T5 - 830	166	830.0
T 22380	6 T5 - 330	66	330.0	T 22413	6 T5 - 840	168	840.0
T 22381	6 T5 - 340	68	340.0	T 49719	6 T5 - 860	172	860.0
T 22382	6 T5 - 350	70	350.0	T 41710	6 T5 - 885	177	885.0
T 22383	6 T5 - 355	71	355.0	T 22415	6 T5 - 900	180	900.0
T 22384	6 T5 - 365	73	365.0	T 49727	6 T5 - 940	188	940.0
T 22385	6 T5 - 390	78	390.0	T 22416	6 T5 - 990	198	990.0
T 22386	6 T5 - 400	80	400.0	T 22418	6 T5 - 1075	215	1075.0
T 22387	6 T5 - 410	82	410.0	T 22419	6 T5 - 1100	220	1100.0
T 22388	6 T5 - 420	84	420.0	T 41711	6 T5 - 1160	232	1160.0
T 22391	6 T5 - 455	91	455.0	T 49775	6 T5 - 1200	240	1200.0
T 49703	6 T5 - 460	92	460.0	T 22420	6 T5 - 1215	243	1215.0
T 22392	6 T5 - 475	95	475.0	T 49735	6 T5 - 1275	255	1275.0
T 22393	6 T5 - 480	96	480.0	T 41712	6 T5 - 1280	256	1280.0
T 22394	6 T5 - 500	100	500.0	T 27323	6 T5 - 1315	263	1315.0
T 22395	6 T5 - 510	102	510.0	T 22421	6 T5 - 1380	276	1380.0
T 22396	6 T5 - 525	105	525.0	T 49743	6 T5 - 1955	391	1955.0
T 22397	6 T5 - 545	109	545.0				

Rozmiary w mm.

### UWAGA:

Koła zębate na zapytanie.

# Pas zębaty T 5

Podziałka 5 mm

Materiał

Poliuretan

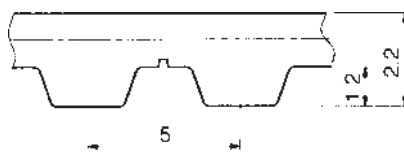

## Szerokość pasa 8 mm

Kod	Oznaczenie	Ilość zębów z	Długość mm	Kod	Oznaczenie	Ilość zębów z	Długość mm
T 64718	8 T5 - 120	24	120.0	T 22457	8 T5 - 545	109	545.0
T 22424	8 T5 - 185	37	185.0	T 22458	8 T5 - 550	110	550.0
T 22425	8 T5 - 200	40	200.0	T 22459	8 T5 - 560	112	560.0
T 49760	8 T5 - 210	42	210.0	T 22460	8 T5 - 575	115	575.0
T 22426	8 T5 - 215	43	215.0	T 49712	8 T5 - 590	118	590.0
T 22427	8 T5 - 220	44	220.0	T 22461	8 T5 - 610	122	610.0
T 22428	8 T5 - 225	45	225.0	T 22462	8 T5 - 620	124	620.0
T 22429	8 T5 - 245	49	245.0	T 22463	8 T5 - 630	126	630.0
T 22430	8 T5 - 250	50	250.0	T 22465	8 T5 - 650	130	650.0
T 22431	8 T5 - 255	51	255.0	T 22466	8 T5 - 660	132	660.0
T 22432	8 T5 - 260	52	260.0	T 22467	8 T5 - 690	138	690.0
T 22433	8 T5 - 270	54	270.0	T 22469	8 T5 - 720	144	720.0
T 22435	8 T5 - 280	56	280.0	T 22470	8 T5 - 750	150	750.0
T 22436	8 T5 - 295	59	295.0	T 22471	8 T5 - 780	156	780.0
T 22437	8 T5 - 300	60	300.0	T 22472	8 T5 - 815	163	815.0
T 22438	8 T5 - 305	61	305.0	T 41713	8 T5 - 830	166	830.0
T 22440	8 T5 - 330	66	330.0	T 22473	8 T5 - 840	168	840.0
T 22441	8 T5 - 340	68	340.0	T 49720	8 T5 - 860	172	860.0
T 22442	8 T5 - 350	70	350.0	T 41714	8 T5 - 885	177	885.0
T 22443	8 T5 - 355	71	355.0	T 22475	8 T5 - 900	180	900.0
T 22444	8 T5 - 365	73	365.0	T 49728	8 T5 - 940	188	940.0
T 22445	8 T5 - 390	78	390.0	T 22476	8 T5 - 990	198	990.0
T 22446	8 T5 - 400	80	400.0	T 22478	8 T5 - 1075	215	1075.0
T 22447	8 T5 - 410	82	410.0	T 22479	8 T5 - 1100	220	1100.0
T 22448	8 T5 - 420	84	420.0	T 41715	8 T5 - 1160	232	1160.0
T 22451	8 T5 - 455	91	455.0	T 49776	8 T5 - 1200	240	1200.0
T 49704	8 T5 - 460	92	460.0	T 22480	8 T5 - 1215	243	1215.0
T 22452	8 T5 - 475	95	475.0	T 49736	8 T5 - 1275	255	1275.0
T 22453	8 T5 - 480	96	480.0	T 41716	8 T5 - 1280	256	1280.0
T 22454	8 T5 - 500	100	500.0	T 27324	8 T5 - 1315	263	1315.0
T 22455	8 T5 - 510	102	510.0	T 22481	8 T5 - 1380	276	1380.0
T 22456	8 T5 - 525	105	525.0	T 49744	8 T5 - 1955	391	1955.0

Rozmiary w mm.

### **UWAGA:**

Koła zębate na zapytanie.

# Pas zębaty T 5

Podziałka 5 mm

Materiał

Poliuretan

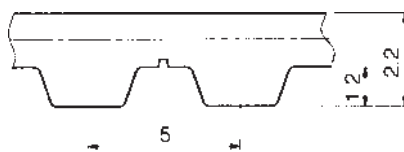

## Szerokość pasa 10 mm

Kod	Oznaczenie	Ilość zębów z	Długość mm	Kod	Oznaczenie	Ilość zębów z	Długość mm
T 64719	10 T5 - 120	24	120.0	T 22842	10 T5 - 550	110	550.0
T 22808	10 T5 - 185	37	185.0	T 22843	10 T5 - 560	112	560.0
T 22809	10 T5 - 200	40	200.0	T 22844	10 T5 - 575	115	575.0
T 49761	10 T5 - 210	42	210.0	T 49713	10 T5 - 590	118	590.0
T 22810	10 T5 - 215	43	215.0	T 22845	10 T5 - 610	122	610.0
T 22811	10 T5 - 220	44	220.0	T 22846	10 T5 - 620	124	620.0
T 22812	10 T5 - 225	45	225.0	T 22847	10 T5 - 630	126	630.0
T 22813	10 T5 - 245	49	245.0	T 22849	10 T5 - 650	130	650.0
T 22814	10 T5 - 250	50	250.0	T 22850	10 T5 - 660	132	660.0
T 22815	10 T5 - 255	51	255.0	T 22851	10 T5 - 690	138	690.0
T 22816	10 T5 - 260	52	260.0	T 22853	10 T5 - 720	144	720.0
T 22817	10 T5 - 270	54	270.0	T 22854	10 T5 - 750	150	750.0
T 22819	10 T5 - 280	56	280.0	T 22855	10 T5 - 780	156	780.0
T 22820	10 T5 - 295	59	295.0	T 22856	10 T5 - 815	163	815.0
T 22822	10 T5 - 305	61	305.0	T 41717	10 T5 - 830	166	830.0
T 22824	10 T5 - 330	66	330.0	T 22857	10 T5 - 840	168	840.0
T 22825	10 T5 - 340	68	340.0	T 49721	10 T5 - 860	172	860.0
T 22826	10 T5 - 350	70	350.0	T 41718	10 T5 - 885	177	885.0
T 22827	10 T5 - 355	71	355.0	T 22859	10 T5 - 900	180	900.0
T 22828	10 T5 - 365	73	365.0	T 49729	10 T5 - 940	188	940.0
T 22829	10 T5 - 390	78	390.0	T 22860	10 T5 - 990	198	990.0
T 22830	10 T5 - 400	80	400.0	T 22862	10 T5 - 1075	215	1075.0
T 22831	10 T5 - 410	82	410.0	T 22863	10 T5 - 1100	220	1100.0
T 22832	10 T5 - 420	84	420.0	T 41719	10 T5 - 1160	232	1160.0
T 22835	10 T5 - 455	91	455.0	T 49777	10 T5 - 1200	240	1200.0
T 49705	10 T5 - 460	92	460.0	T 22864	10 T5 - 1215	243	1215.0
T 22836	10 T5 - 475	95	475.0	T 49737	10 T5 - 1275	255	1275.0
T 22837	10 T5 - 480	96	480.0	T 41720	10 T5 - 1280	256	1280.0
T 22838	10 T5 - 500	100	500.0	T 27325	10 T5 - 1315	263	1315.0
T 22839	10 T5 - 510	102	510.0	T 22865	10 T5 - 1380	276	1380.0
T 22840	10 T5 - 525	105	525.0	T 49745	10 T5 - 1955	391	1955.0
T 22841	10 T5 - 545	109	545.0				

Rozmiary w mm.

### **UWAGA:**

Koła zębate patrz strona H 3.

# Pas zębaty T 5

Podziałka 5 mm

Materiał

Poliuretan

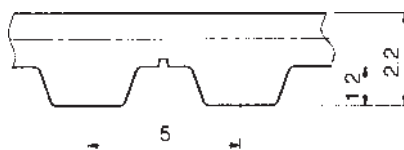

## Szerokość pasa 12 mm

Kod	Oznaczenie	Ilość zębów z	Długość mm	Kod	Oznaczenie	Ilość zębów z	Długość mm
T 64720	12 T5 - 120	24	120.0	T 22902	12 T5 - 550	110	550.0
T 22868	12 T5 - 185	37	185.0	T 22903	12 T5 - 560	112	560.0
T 22869	12 T5 - 200	40	200.0	T 22904	12 T5 - 575	115	575.0
T 49762	12 T5 - 210	42	210.0	T 49714	12 T5 - 590	118	590.0
T 22870	12 T5 - 215	43	215.0	T 22905	12 T5 - 610	122	610.0
T 22871	12 T5 - 220	44	220.0	T 22906	12 T5 - 620	124	620.0
T 22872	12 T5 - 225	45	225.0	T 22907	12 T5 - 630	126	630.0
T 22873	12 T5 - 245	49	245.0	T 22909	12 T5 - 650	130	650.0
T 22874	12 T5 - 250	50	250.0	T 22910	12 T5 - 660	132	660.0
T 22875	12 T5 - 255	51	255.0	T 22911	12 T5 - 690	138	690.0
T 22876	12 T5 - 260	52	260.0	T 22913	12 T5 - 720	144	720.0
T 22877	12 T5 - 270	54	270.0	T 22914	12 T5 - 750	150	750.0
T 22879	12 T5 - 280	56	280.0	T 22915	12 T5 - 780	156	780.0
T 22880	12 T5 - 295	59	295.0	T 22916	12 T5 - 815	163	815.0
T 22882	12 T5 - 305	61	305.0	T 41721	12 T5 - 830	166	830.0
T 22884	12 T5 - 330	66	330.0	T 22917	12 T5 - 840	168	840.0
T 22885	12 T5 - 340	68	340.0	T 49722	12 T5 - 860	172	860.0
T 22886	12 T5 - 350	70	350.0	T 41722	12 T5 - 885	177	885.0
T 22887	12 T5 - 355	71	355.0	T 22919	12 T5 - 900	180	900.0
T 22888	12 T5 - 365	73	365.0	T 49730	12 T5 - 940	188	940.0
T 22889	12 T5 - 390	78	390.0	T 22920	12 T5 - 990	198	990.0
T 22890	12 T5 - 400	80	400.0	T 22922	12 T5 - 1075	215	1075.0
T 22891	12 T5 - 410	82	410.0	T 22923	12 T5 - 1100	220	1100.0
T 22892	12 T5 - 420	84	420.0	T 41723	12 T5 - 1160	232	1160.0
T 22895	12 T5 - 455	91	455.0	T 49778	12 T5 - 1200	240	1200.0
T 49706	12 T5 - 460	92	460.0	T 22924	12 T5 - 1215	243	1215.0
T 22896	12 T5 - 475	95	475.0	T 49738	12 T5 - 1275	255	1275.0
T 22897	12 T5 - 480	96	480.0	T 41724	12 T5 - 1280	256	1280.0
T 22898	12 T5 - 500	100	500.0	T 27326	12 T5 - 1315	263	1315.0
T 22899	12 T5 - 510	102	510.0	T 22925	12 T5 - 1380	276	1380.0
T 22900	12 T5 - 525	105	525.0	T 49746	12 T5 - 1955	391	1955.0
T 22901	12 T5 - 545	109	545.0				

Rozmiary w mm.

### UWAGA:

Koła zębate na zapytanie.



# Pas zębaty T 5

Podziałka 5 mm

Materiał

Poliuretan

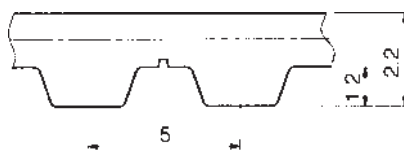

## Szerokość pasa 16 mm

Kod	Oznaczenie	Ilość zębów z	Długość mm	Kod	Oznaczenie	Ilość zębów z	Długość mm
T 64721	16 T5 - 120	24	120.0	T 22962	16 T5 - 550	110	550.0
T 22928	16 T5 - 185	37	185.0	T 22963	16 T5 - 560	112	560.0
T 22929	16 T5 - 200	40	200.0	T 22964	16 T5 - 575	115	575.0
T 49763	16 T5 - 210	42	210.0	T 49715	16 T5 - 590	118	590.0
T 22930	16 T5 - 215	43	215.0	T 22965	16 T5 - 610	122	610.0
T 22931	16 T5 - 220	44	220.0	T 22966	16 T5 - 620	124	620.0
T 22932	16 T5 - 225	45	225.0	T 22967	16 T5 - 630	126	630.0
T 22933	16 T5 - 245	49	245.0	T 22969	16 T5 - 650	130	650.0
T 22934	16 T5 - 250	50	250.0	T 22970	16 T5 - 660	132	660.0
T 22935	16 T5 - 255	51	255.0	T 22971	16 T5 - 690	138	690.0
T 22936	16 T5 - 260	52	260.0	T 22973	16 T5 - 720	144	720.0
T 22937	16 T5 - 270	54	270.0	T 22974	16 T5 - 750	150	750.0
T 22939	16 T5 - 280	56	280.0	T 22975	16 T5 - 780	156	780.0
T 22940	16 T5 - 295	59	295.0	T 22976	16 T5 - 815	163	815.0
T 22942	16 T5 - 305	61	305.0	T 41725	16 T5 - 830	166	830.0
T 22944	16 T5 - 330	66	330.0	T 22977	16 T5 - 840	168	840.0
T 22945	16 T5 - 340	68	340.0	T 49723	16 T5 - 860	172	860.0
T 22946	16 T5 - 350	70	350.0	T 41726	16 T5 - 885	177	885.0
T 22947	16 T5 - 355	71	355.0	T 22979	16 T5 - 900	180	900.0
T 22948	16 T5 - 365	73	365.0	T 49731	16 T5 - 940	188	940.0
T 22949	16 T5 - 390	78	390.0	T 22980	16 T5 - 990	198	990.0
T 22950	16 T5 - 400	80	400.0	T 22982	16 T5 - 1075	215	1075.0
T 22951	16 T5 - 410	82	410.0	T 22983	16 T5 - 1100	220	1100.0
T 22952	16 T5 - 420	84	420.0	T 41727	16 T5 - 1160	232	1160.0
T 22955	16 T5 - 455	91	455.0	T 49779	16 T5 - 1200	240	1200.0
T 49707	16 T5 - 460	92	460.0	T 22984	16 T5 - 1215	243	1215.0
T 22956	16 T5 - 475	95	475.0	T 49739	16 T5 - 1275	255	1275.0
T 22957	16 T5 - 480	96	480.0	T 41728	16 T5 - 1280	256	1280.0
T 22958	16 T5 - 500	100	500.0	T 27327	16 T5 - 1315	263	1315.0
T 22959	16 T5 - 510	102	510.0	T 22985	16 T5 - 1380	276	1380.0
T 22960	16 T5 - 525	105	525.0	T 49747	16 T5 - 1955	391	1955.0
T 22961	16 T5 - 545	109	545.0				

Rozmiary w mm.

### UWAGA:

Koła zębate patrz strona H 3 - H 4.

# Pas zębaty T 5

Podziałka 5 mm

Materiał

Poliuretan

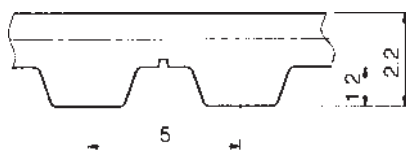

## Szerokość pasa 20 mm

Kod	Oznaczenie	Ilość zębów z	Długość mm	Kod	Oznaczenie	Ilość zębów z	Długość mm
T 64722	20 T5 - 120	24	120.0	T 23022	20 T5 - 550	110	550.0
T 22988	20 T5 - 185	37	185.0	T 23023	20 T5 - 560	112	560.0
T 22989	20 T5 - 200	40	200.0	T 23024	20 T5 - 575	115	575.0
T 49764	20 T5 - 210	42	210.0	T 49716	20 T5 - 590	118	590.0
T 22990	20 T5 - 215	43	215.0	T 23025	20 T5 - 610	122	610.0
T 22991	20 T5 - 220	44	220.0	T 23026	20 T5 - 620	124	620.0
T 22992	20 T5 - 225	45	225.0	T 23027	20 T5 - 630	126	630.0
T 22993	20 T5 - 245	49	245.0	T 23029	20 T5 - 650	130	650.0
T 22994	20 T5 - 250	50	250.0	T 23030	20 T5 - 660	132	660.0
T 22995	20 T5 - 255	51	255.0	T 23031	20 T5 - 690	138	690.0
T 22996	20 T5 - 260	52	260.0	T 23033	20 T5 - 720	144	720.0
T 22997	20 T5 - 270	54	270.0	T 23034	20 T5 - 750	150	750.0
T 22999	20 T5 - 280	56	280.0	T 23035	20 T5 - 780	156	780.0
T 23000	20 T5 - 295	59	295.0	T 23036	20 T5 - 815	163	815.0
T 23002	20 T5 - 305	61	305.0	T 41729	20 T5 - 830	166	830.0
T 23004	20 T5 - 330	66	330.0	T 23037	20 T5 - 840	168	840.0
T 23005	20 T5 - 340	68	340.0	T 49724	20 T5 - 860	172	860.0
T 23006	20 T5 - 350	70	350.0	T 41730	20 T5 - 885	177	885.0
T 23007	20 T5 - 355	71	355.0	T 23039	20 T5 - 900	180	900.0
T 23008	20 T5 - 365	73	365.0	T 49732	20 T5 - 940	188	940.0
T 23009	20 T5 - 390	78	390.0	T 23040	20 T5 - 990	198	990.0
T 23010	20 T5 - 400	80	400.0	T 23042	20 T5 - 1075	215	1075.0
T 23011	20 T5 - 410	82	410.0	T 23043	20 T5 - 1100	220	1100.0
T 23012	20 T5 - 420	84	420.0	T 41731	20 T5 - 1160	232	1160.0
T 23015	20 T5 - 455	91	455.0	T 49780	20 T5 - 1200	240	1200.0
T 49708	20 T5 - 460	92	460.0	T 23044	20 T5 - 1215	243	1215.0
T 23016	20 T5 - 475	95	475.0	T 49740	20 T5 - 1275	255	1275.0
T 23017	20 T5 - 480	96	480.0	T 41732	20 T5 - 1280	256	1280.0
T 23018	20 T5 - 500	100	500.0	T 27328	20 T5 - 1315	263	1315.0
T 23019	20 T5 - 510	102	510.0	T 23045	20 T5 - 1380	276	1380.0
T 23020	20 T5 - 525	105	525.0	T 49748	20 T5 - 1955	391	1955.0
T 23021	20 T5 - 545	109	545.0				

Rozmiary w mm.

### UWAGA:

Koła zębate na zapytanie.

# Pas zębaty T 5

Podziałka 5 mm

Materiał

Poliuretan

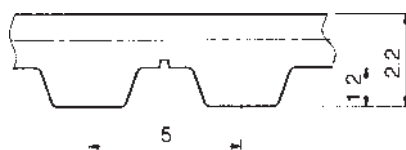

## Szerokość pasa 25 mm

Kod	Oznaczenie	Ilość zębów z	Długość mm	Kod	Oznaczenie	Ilość zębów z	Długość mm
T 64723	25 T5 - 120	24	120.0	T 23082	25 T5 - 550	110	550.0
T 23048	25 T5 - 185	37	185.0	T 23083	25 T5 - 560	112	560.0
T 23049	25 T5 - 200	40	200.0	T 23084	25 T5 - 575	115	575.0
T 49765	25 T5 - 210	42	210.0	T 49717	25 T5 - 590	118	590.0
T 23050	25 T5 - 215	43	215.0	T 23085	25 T5 - 610	122	610.0
T 23051	25 T5 - 220	44	220.0	T 23086	25 T5 - 620	124	620.0
T 23052	25 T5 - 225	45	225.0	T 23087	25 T5 - 630	126	630.0
T 23053	25 T5 - 245	49	245.0	T 23089	25 T5 - 650	130	650.0
T 23054	25 T5 - 250	50	250.0	T 23090	25 T5 - 660	132	660.0
T 23055	25 T5 - 255	51	255.0	T 23091	25 T5 - 690	138	690.0
T 23056	25 T5 - 260	52	260.0	T 23093	25 T5 - 720	144	720.0
T 23057	25 T5 - 270	54	270.0	T 23094	25 T5 - 750	150	750.0
T 23059	25 T5 - 280	56	280.0	T 23095	25 T5 - 780	156	780.0
T 23060	25 T5 - 295	59	295.0	T 23096	25 T5 - 815	163	815.0
T 23062	25 T5 - 305	61	305.0	T 41733	25 T5 - 830	166	830.0
T 23064	25 T5 - 330	66	330.0	T 23097	25 T5 - 840	168	840.0
T 23065	25 T5 - 340	68	340.0	T 49725	25 T5 - 860	172	860.0
T 23066	25 T5 - 350	70	350.0	T 41734	25 T5 - 885	177	885.0
T 23067	25 T5 - 355	71	355.0	T 23099	25 T5 - 900	180	900.0
T 23068	25 T5 - 365	73	365.0	T 49733	25 T5 - 940	188	940.0
T 23069	25 T5 - 390	78	390.0	T 23100	25 T5 - 990	198	990.0
T 23070	25 T5 - 400	80	400.0	T 23102	25 T5 - 1075	215	1075.0
T 23071	25 T5 - 410	82	410.0	T 23103	25 T5 - 1100	220	1100.0
T 23072	25 T5 - 420	84	420.0	T 41735	25 T5 - 1160	232	1160.0
T 23075	25 T5 - 455	91	455.0	T 49781	25 T5 - 1200	240	1200.0
T 49709	25 T5 - 460	92	460.0	T 23104	25 T5 - 1215	243	1215.0
T 23076	25 T5 - 475	95	475.0	T 49741	25 T5 - 1275	255	1275.0
T 23077	25 T5 - 480	96	480.0	T 41736	25 T5 - 1280	256	1280.0
T 23078	25 T5 - 500	100	500.0	T 27329	25 T5 - 1315	263	1315.0
T 23079	25 T5 - 510	102	510.0	T 23105	25 T5 - 1380	276	1380.0
T 23080	25 T5 - 525	105	525.0	T 49749	25 T5 - 1955	391	1955.0
T 23081	25 T5 - 545	109	545.0				

Rozmiary w mm.

### UWAGA:

Koła zębate patrz strona H 4.

# Pas zębaty T 5

Podziałka 5 mm

Materiał

Poliuretan

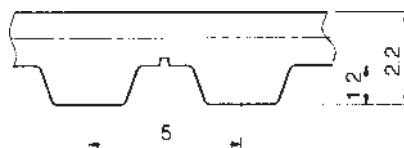

## Szerokość pasa 32 mm

Kod	Oznaczenie	Ilość zębów z	Długość mm	Kod	Oznaczenie	Ilość zębów z	Długość mm
T 64724	32 T5 - 120	24	120.0	T 23142	32 T5 - 550	110	550.0
T 23108	32 T5 - 185	37	185.0	T 23143	32 T5 - 560	112	560.0
T 23109	32 T5 - 200	40	200.0	T 23144	32 T5 - 575	115	575.0
T 49766	32 T5 - 210	42	210.0	T 49718	32 T5 - 590	118	590.0
T 23110	32 T5 - 215	43	215.0	T 23145	32 T5 - 610	122	610.0
T 23111	32 T5 - 220	44	220.0	T 23146	32 T5 - 620	124	620.0
T 23112	32 T5 - 225	45	225.0	T 23147	32 T5 - 630	126	630.0
T 23113	32 T5 - 245	49	245.0	T 23149	32 T5 - 650	130	650.0
T 23114	32 T5 - 250	50	250.0	T 23150	32 T5 - 660	132	660.0
T 23115	32 T5 - 255	51	255.0	T 23151	32 T5 - 690	138	690.0
T 23116	32 T5 - 260	52	260.0	T 23153	32 T5 - 720	144	720.0
T 23117	32 T5 - 270	54	270.0	T 23154	32 T5 - 750	150	750.0
T 23119	32 T5 - 280	56	280.0	T 23155	32 T5 - 780	156	780.0
T 23120	32 T5 - 295	59	295.0	T 23156	32 T5 - 815	163	815.0
T 23122	32 T5 - 305	61	305.0	T 41737	32 T5 - 830	166	830.0
T 23124	32 T5 - 330	66	330.0	T 23157	32 T5 - 840	168	840.0
T 23125	32 T5 - 340	68	340.0	T 49726	32 T5 - 860	172	860.0
T 23126	32 T5 - 350	70	350.0	T 41738	32 T5 - 885	177	885.0
T 23127	32 T5 - 355	71	355.0	T 23159	32 T5 - 900	180	900.0
T 23128	32 T5 - 365	73	365.0	T 49734	32 T5 - 940	188	940.0
T 23129	32 T5 - 390	78	390.0	T 23160	32 T5 - 990	198	990.0
T 23130	32 T5 - 400	80	400.0	T 23162	32 T5 - 1075	215	1075.0
T 23131	32 T5 - 410	82	410.0	T 23163	32 T5 - 1100	220	1100.0
T 23132	32 T5 - 420	84	420.0	T 41739	32 T5 - 1160	232	1160.0
T 23135	32 T5 - 455	91	455.0	T 49782	32 T5 - 1200	240	1200.0
T 49710	32 T5 - 460	92	460.0	T 23164	32 T5 - 1215	243	1215.0
T 23136	32 T5 - 475	95	475.0	T 49742	32 T5 - 1275	255	1275.0
T 23137	32 T5 - 480	96	480.0	T 41740	32 T5 - 1280	256	1280.0
T 23138	32 T5 - 500	100	500.0	T 27330	32 T5 - 1315	263	1315.0
T 23139	32 T5 - 510	102	510.0	T 23165	32 T5 - 1380	276	1380.0
T 23140	32 T5 - 525	105	525.0	T 49750	32 T5 - 1955	391	1955.0
T 23141	32 T5 - 545	109	545.0				

Rozmiary w mm.

### UWAGA:

Koła zębate na zapytanie.

# Pas zębaty T 10

Podziałka 10 mm

Materiał

Poliuretan

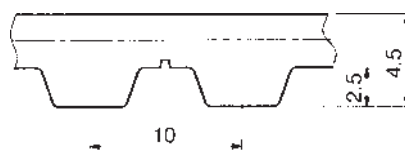

## Szerokość pasa 10 mm

Kod	Oznaczenie	Ilość zębów z	Długość mm	Kod	Oznaczenie	Ilość zębów z	Długość mm
T 23167	10 T10 - 260	26	260.0	T 23190	10 T10 - 960	96	960.0
T 41741	10 T10 - 340	34	340.0	T 23191	10 T10 - 970	97	970.0
T 23168	10 T10 - 370	37	370.0	T 23192	10 T10 - 980	98	980.0
T 23169	10 T10 - 400	40	400.0	T 23193	10 T10 - 1010	101	1010.0
T 23170	10 T10 - 410	41	410.0	T 23194	10 T10 - 1080	108	1080.0
T 23171	10 T10 - 440	44	440.0	T 23195	10 T10 - 1110	111	1110.0
T 41742	10 T10 - 480	48	480.0	T 23196	10 T10 - 1140	114	1140.0
T 23173	10 T10 - 500	50	500.0	T 23197	10 T10 - 1150	115	1150.0
T 23174	10 T10 - 530	53	530.0	T 23198	10 T10 - 1210	121	1210.0
T 23175	10 T10 - 560	56	560.0	T 23199	10 T10 - 1240	124	1240.0
T 37640	10 T10 - 600	60	600.0	T 23200	10 T10 - 1250	125	1250.0
T 23176	10 T10 - 610	61	610.0	T 23201	10 T10 - 1300	130	1300.0
T 23177	10 T10 - 630	63	630.0	T 23202	10 T10 - 1320	132	1320.0
T 23178	10 T10 - 660	66	660.0	T 23203	10 T10 - 1350	135	1350.0
T 64707	10 T10 - 680	68	680.0	T 23204	10 T10 - 1390	139	1390.0
T 23179	10 T10 - 690	69	690.0	T 23205	10 T10 - 1400	140	1400.0
T 23180	10 T10 - 700	70	700.0	T 23206	10 T10 - 1420	142	1420.0
T 23181	10 T10 - 720	72	720.0	T 23209	10 T10 - 1460	146	1460.0
T 64829	10 T10 - 730	73	730.0	T 23210	10 T10 - 1500	150	1500.0
T 23182	10 T10 - 750	75	750.0	T 23211	10 T10 - 1560	156	1560.0
T 23183	10 T10 - 780	78	780.0	T 23212	10 T10 - 1610	161	1610.0
T 23184	10 T10 - 810	81	810.0	T 23213	10 T10 - 1750	175	1750.0
T 23185	10 T10 - 840	84	840.0	T 23214	10 T10 - 1780	178	1780.0
T 23186	10 T10 - 880	88	880.0	T 23215	10 T10 - 1880	188	1880.0
T 23187	10 T10 - 890	89	890.0	T 23216	10 T10 - 1960	196	1960.0
T 23188	10 T10 - 900	90	900.0	T 23217	10 T10 - 2250	225	2250.0
T 23189	10 T10 - 920	92	920.0				

Rozmiary w mm.

### UWAGA:

Koła zębate na zapytanie.

# Pas zębaty T 10

Podziałka 10 mm

Materiał

Poliuretan

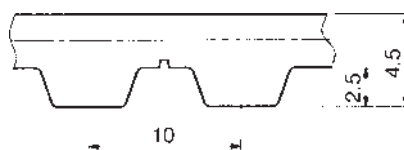

## Szerokość pasa 12 mm

Kod	Oznaczenie	Ilość zębów z	Długość mm	Kod	Oznaczenie	Ilość zębów z	Długość mm
T 23271	12 T10 - 260	26	260.0	T 23294	12 T10 - 960	96	960.0
T 41743	12 T10 - 340	34	340.0	T 23295	12 T10 - 970	97	970.0
T 23272	12 T10 - 370	37	370.0	T 23296	12 T10 - 980	98	980.0
T 23273	12 T10 - 400	40	400.0	T 23297	12 T10 - 1010	101	1010.0
T 23274	12 T10 - 410	41	410.0	T 23298	12 T10 - 1080	108	1080.0
T 23275	12 T10 - 440	44	440.0	T 23299	12 T10 - 1110	111	1110.0
T 41744	12 T10 - 480	48	480.0	T 23300	12 T10 - 1140	114	1140.0
T 23277	12 T10 - 500	50	500.0	T 23301	12 T10 - 1150	115	1150.0
T 23278	12 T10 - 530	53	530.0	T 23302	12 T10 - 1210	121	1210.0
T 23279	12 T10 - 560	56	560.0	T 23303	12 T10 - 1240	124	1240.0
T 37641	12 T10 - 600	60	600.0	T 23304	12 T10 - 1250	125	1250.0
T 23280	12 T10 - 610	61	610.0	T 23305	12 T10 - 1300	130	1300.0
T 23281	12 T10 - 630	63	630.0	T 23306	12 T10 - 1320	132	1320.0
T 23282	12 T10 - 660	66	660.0	T 23307	12 T10 - 1350	135	1350.0
T 64708	12 T10 - 680	68	680.0	T 23308	12 T10 - 1390	139	1390.0
T 23283	12 T10 - 690	69	690.0	T 23309	12 T10 - 1400	140	1400.0
T 23284	12 T10 - 700	70	700.0	T 23310	12 T10 - 1420	142	1420.0
T 23285	12 T10 - 720	72	720.0	T 23313	12 T10 - 1460	146	1460.0
T 64830	12 T10 - 730	73	730.0	T 23314	12 T10 - 1500	150	1500.0
T 23286	12 T10 - 750	75	750.0	T 23315	12 T10 - 1560	156	1560.0
T 23287	12 T10 - 780	78	780.0	T 23316	12 T10 - 1610	161	1610.0
T 23288	12 T10 - 810	81	810.0	T 23317	12 T10 - 1750	175	1750.0
T 23289	12 T10 - 840	84	840.0	T 23318	12 T10 - 1780	178	1780.0
T 23290	12 T10 - 880	88	880.0	T 23319	12 T10 - 1880	188	1880.0
T 23291	12 T10 - 890	89	890.0	T 23320	12 T10 - 1960	196	1960.0
T 23292	12 T10 - 900	90	900.0	T 23321	12 T10 - 2250	225	2250.0
T 23293	12 T10 - 920	92	920.0				

Rozmiary w mm.

### UWAGA:

Koła zębate na zapytanie.

# Pas zębaty T 10

Podziałka 10 mm

Material

Poliuretan

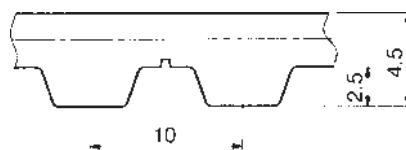

## Szerokość pasa 16 mm

Kod	Oznaczenie	Ilość zębów z	Długość mm	Kod	Oznaczenie	Ilość zębów z	Długość mm
T 23322	16 T10 - 260	26	260.0	T 23345	16 T10 - 960	96	960.0
T 41745	16 T10 - 340	34	340.0	T 23346	16 T10 - 970	97	970.0
T 23323	16 T10 - 370	37	370.0	T 23347	16 T10 - 980	98	980.0
T 23324	16 T10 - 400	40	400.0	T 23348	16 T10 - 1010	101	1010.0
T 23325	16 T10 - 410	41	410.0	T 23349	16 T10 - 1080	108	1080.0
T 23326	16 T10 - 440	44	440.0	T 23350	16 T10 - 1110	111	1110.0
T 41746	16 T10 - 480	48	480.0	T 23351	16 T10 - 1140	114	1140.0
T 23328	16 T10 - 500	50	500.0	T 23352	16 T10 - 1150	115	1150.0
T 23329	16 T10 - 530	53	530.0	T 23353	16 T10 - 1210	121	1210.0
T 23330	16 T10 - 560	56	560.0	T 23354	16 T10 - 1240	124	1240.0
T 37642	16 T10 - 600	60	600.0	T 23355	16 T10 - 1250	125	1250.0
T 23331	16 T10 - 610	61	610.0	T 23356	16 T10 - 1300	130	1300.0
T 23332	16 T10 - 630	63	630.0	T 23357	16 T10 - 1320	132	1320.0
T 23333	16 T10 - 660	66	660.0	T 23358	16 T10 - 1350	135	1350.0
T 64709	16 T10 - 680	68	680.0	T 23359	16 T10 - 1390	139	1390.0
T 23334	16 T10 - 690	69	690.0	T 23360	16 T10 - 1400	140	1400.0
T 23335	16 T10 - 700	70	700.0	T 23361	16 T10 - 1420	142	1420.0
T 23336	16 T10 - 720	72	720.0	T 23364	16 T10 - 1460	146	1460.0
T 64831	16 T10 - 730	73	730.0	T 23365	16 T10 - 1500	150	1500.0
T 23337	16 T10 - 750	75	750.0	T 23366	16 T10 - 1560	156	1560.0
T 23338	16 T10 - 780	78	780.0	T 23367	16 T10 - 1610	161	1610.0
T 23339	16 T10 - 810	81	810.0	T 23368	16 T10 - 1750	175	1750.0
T 23340	16 T10 - 840	84	840.0	T 23369	16 T10 - 1780	178	1780.0
T 23341	16 T10 - 880	88	880.0	T 23370	16 T10 - 1880	188	1880.0
T 23342	16 T10 - 890	89	890.0	T 23371	16 T10 - 1960	196	1960.0
T 23343	16 T10 - 900	90	900.0	T 23372	16 T10 - 2250	225	2250.0
T 23344	16 T10 - 920	92	920.0				

Rozmiary w mm.

### UWAGA:

Koła zębate patrz strona H 5.

# Pas zębaty T 10

Podziałka 10 mm

Material

Poliuretan

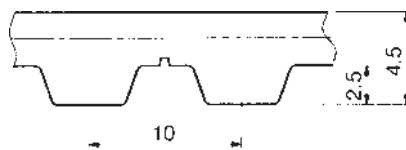

## Szerokość pasa 20 mm

Kod	Oznaczenie	Ilość zębów z	Długość mm	Kod	Oznaczenie	Ilość zębów z	Długość mm
T 23373	20 T10 - 260	26	260.0	T 23396	20 T10 - 960	96	960.0
T 41747	20 T10 - 340	34	340.0	T 23397	20 T10 - 970	97	970.0
T 23374	20 T10 - 370	37	370.0	T 23398	20 T10 - 980	98	980.0
T 23375	20 T10 - 400	40	400.0	T 23399	20 T10 - 1010	101	1010.0
T 23376	20 T10 - 410	41	410.0	T 23400	20 T10 - 1080	108	1080.0
T 23377	20 T10 - 440	44	440.0	T 23401	20 T10 - 1110	111	1110.0
T 41748	20 T10 - 480	48	480.0	T 23402	20 T10 - 1140	114	1140.0
T 23379	20 T10 - 500	50	500.0	T 23403	20 T10 - 1150	115	1150.0
T 23380	20 T10 - 530	53	530.0	T 23404	20 T10 - 1210	121	1210.0
T 23381	20 T10 - 560	56	560.0	T 23405	20 T10 - 1240	124	1240.0
T 37643	20 T10 - 600	60	600.0	T 23406	20 T10 - 1250	125	1250.0
T 23382	20 T10 - 610	61	610.0	T 23407	20 T10 - 1300	130	1300.0
T 23383	20 T10 - 630	63	630.0	T 23408	20 T10 - 1320	132	1320.0
T 23384	20 T10 - 660	66	660.0	T 23409	20 T10 - 1350	135	1350.0
T 64710	20 T10 - 680	68	680.0	T 23410	20 T10 - 1390	139	1390.0
T 23385	20 T10 - 690	69	690.0	T 23411	20 T10 - 1400	140	1400.0
T 23386	20 T10 - 700	70	700.0	T 23412	20 T10 - 1420	142	1420.0
T 23387	20 T10 - 720	72	720.0	T 23415	20 T10 - 1460	146	1460.0
T 64832	20 T10 - 730	73	730.0	T 23416	20 T10 - 1500	150	1500.0
T 23388	20 T10 - 750	75	750.0	T 23417	20 T10 - 1560	156	1560.0
T 23389	20 T10 - 780	78	780.0	T 23418	20 T10 - 1610	161	1610.0
T 23390	20 T10 - 810	81	810.0	T 23419	20 T10 - 1750	175	1750.0
T 23391	20 T10 - 840	84	840.0	T 23420	20 T10 - 1780	178	1780.0
T 23392	20 T10 - 880	88	880.0	T 23421	20 T10 - 1880	188	1880.0
T 23393	20 T10 - 890	89	890.0	T 23422	20 T10 - 1960	196	1960.0
T 23394	20 T10 - 900	90	900.0	T 23423	20 T10 - 2250	225	2250.0
T 23395	20 T10 - 920	92	920.0				

Rozmiary w mm.

### UWAGA:

Koła zębate na zapytanie.



# Pas zębaty T 10

Podziałka 10 mm

Material

Poliuretan

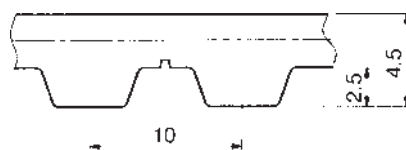

## Szerokość pasa 25 mm

Kod	Oznaczenie	Ilość zębów z	Długość mm	Kod	Oznaczenie	Ilość zębów z	Długość mm
T 23424	25 T10 - 260	26	260.0	T 23447	25 T10 - 960	96	960.0
T 41749	25 T10 - 340	34	340.0	T 23448	25 T10 - 970	97	970.0
T 23425	25 T10 - 370	37	370.0	T 23449	25 T10 - 980	98	980.0
T 23426	25 T10 - 400	40	400.0	T 23450	25 T10 - 1010	101	1010.0
T 23427	25 T10 - 410	41	410.0	T 23451	25 T10 - 1080	108	1080.0
T 23428	25 T10 - 440	44	440.0	T 23452	25 T10 - 1110	111	1110.0
T 41750	25 T10 - 480	48	480.0	T 23453	25 T10 - 1140	114	1140.0
T 23430	25 T10 - 500	50	500.0	T 23454	25 T10 - 1150	115	1150.0
T 23431	25 T10 - 530	53	530.0	T 23455	25 T10 - 1210	121	1210.0
T 23432	25 T10 - 560	56	560.0	T 23456	25 T10 - 1240	124	1240.0
T 37644	25 T10 - 600	60	600.0	T 23457	25 T10 - 1250	125	1250.0
T 23433	25 T10 - 610	61	610.0	T 23458	25 T10 - 1300	130	1300.0
T 23434	25 T10 - 630	63	630.0	T 23459	25 T10 - 1320	132	1320.0
T 23435	25 T10 - 660	66	660.0	T 23460	25 T10 - 1350	135	1350.0
T 64711	25 T10 - 680	68	680.0	T 23461	25 T10 - 1390	139	1390.0
T 23436	25 T10 - 690	69	690.0	T 23462	25 T10 - 1400	140	1400.0
T 23437	25 T10 - 700	70	700.0	T 23463	25 T10 - 1420	142	1420.0
T 23438	25 T10 - 720	72	720.0	T 23466	25 T10 - 1460	146	1460.0
T 64833	25 T10 - 730	73	730.0	T 23467	25 T10 - 1500	150	1500.0
T 23439	25 T10 - 750	75	750.0	T 23468	25 T10 - 1560	156	1560.0
T 23440	25 T10 - 780	78	780.0	T 23469	25 T10 - 1610	161	1610.0
T 23441	25 T10 - 810	81	810.0	T 23470	25 T10 - 1750	175	1750.0
T 23442	25 T10 - 840	84	840.0	T 23471	25 T10 - 1780	178	1780.0
T 23443	25 T10 - 880	88	880.0	T 23472	25 T10 - 1880	188	1880.0
T 23444	25 T10 - 890	89	890.0	T 23473	25 T10 - 1960	196	1960.0
T 23445	25 T10 - 900	90	900.0	T 23474	25 T10 - 2250	225	2250.0
T 23446	25 T10 - 920	92	920.0				

Rozmiary w mm.

### UWAGA:

Koła zębate patrz strona H 5.

# Pas zębaty T 10

Podziałka 10 mm

Materiał

Poliuretan

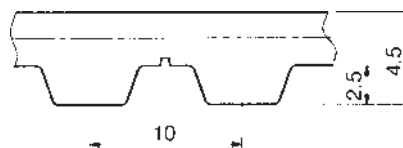

## Szerokość pasa 32 mm

Kod	Oznaczenie	Ilość zębów z	Długość mm	Kod	Oznaczenie	Ilość zębów z	Długość mm
T 23475	32 T10 - 260	26	260.0	T 23498	32 T10 - 960	96	960.0
T 41751	32 T10 - 340	34	340.0	T 23499	32 T10 - 970	97	970.0
T 23476	32 T10 - 370	37	370.0	T 23500	32 T10 - 980	98	980.0
T 23477	32 T10 - 400	40	400.0	T 23501	32 T10 - 1010	101	1010.0
T 23478	32 T10 - 410	41	410.0	T 23502	32 T10 - 1080	108	1080.0
T 23479	32 T10 - 440	44	440.0	T 23503	32 T10 - 1110	111	1110.0
T 41752	32 T10 - 480	48	480.0	T 23504	32 T10 - 1140	114	1140.0
T 23481	32 T10 - 500	50	500.0	T 23505	32 T10 - 1150	115	1150.0
T 23482	32 T10 - 530	53	530.0	T 23506	32 T10 - 1210	121	1210.0
T 23483	32 T10 - 560	56	560.0	T 23507	32 T10 - 1240	124	1240.0
T 37645	32 T10 - 600	60	600.0	T 23508	32 T10 - 1250	125	1250.0
T 23484	32 T10 - 610	61	610.0	T 23509	32 T10 - 1300	130	1300.0
T 23485	32 T10 - 630	63	630.0	T 23510	32 T10 - 1320	132	1320.0
T 23486	32 T10 - 660	66	660.0	T 23511	32 T10 - 1350	135	1350.0
T 64712	32 T10 - 680	68	680.0	T 23512	32 T10 - 1390	139	1390.0
T 23487	32 T10 - 690	69	690.0	T 23513	32 T10 - 1400	140	1400.0
T 23488	32 T10 - 700	70	700.0	T 23514	32 T10 - 1420	142	1420.0
T 23489	32 T10 - 720	72	720.0	T 23517	32 T10 - 1460	146	1460.0
T 64834	32 T10 - 730	73	730.0	T 23518	32 T10 - 1500	150	1500.0
T 23490	32 T10 - 750	75	750.0	T 23519	32 T10 - 1560	156	1560.0
T 23491	32 T10 - 780	78	780.0	T 23520	32 T10 - 1610	161	1610.0
T 23492	32 T10 - 810	81	810.0	T 23521	32 T10 - 1750	175	1750.0
T 23493	32 T10 - 840	84	840.0	T 23522	32 T10 - 1780	178	1780.0
T 23494	32 T10 - 880	88	880.0	T 23523	32 T10 - 1880	188	1880.0
T 23495	32 T10 - 890	89	890.0	T 23524	32 T10 - 1960	196	1960.0
T 23496	32 T10 - 900	90	900.0	T 23525	32 T10 - 2250	225	2250.0
T 23497	32 T10 - 920	92	920.0				

Rozmiary w mm.

### UWAGA:

Koła zębate patrz strona H 6.

# Pas zębaty T 10

Podziałka 10 mm

Materiał

Poliuretan

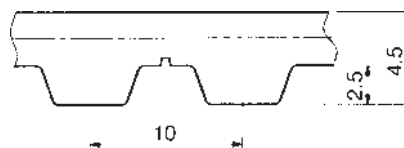

## Szerokość pasa 50 mm

Kod	Oznaczenie	Ilość zębów z	Długość mm	Kod	Oznaczenie	Ilość zębów z	Długość mm
T 23526	50 T10 - 260	26	260.0	T 23549	50 T10 - 960	96	960.0
T 41753	50 T10 - 340	34	340.0	T 23550	50 T10 - 970	97	970.0
T 23527	50 T10 - 370	37	370.0	T 23551	50 T10 - 980	98	980.0
T 23528	50 T10 - 400	40	400.0	T 23552	50 T10 - 1010	101	1010.0
T 23529	50 T10 - 410	41	410.0	T 23553	50 T10 - 1080	108	1080.0
T 23530	50 T10 - 440	44	440.0	T 23554	50 T10 - 1110	111	1110.0
T 41754	50 T10 - 480	48	480.0	T 23555	50 T10 - 1140	114	1140.0
T 23532	50 T10 - 500	50	500.0	T 23556	50 T10 - 1150	115	1150.0
T 23533	50 T10 - 530	53	530.0	T 23557	50 T10 - 1210	121	1210.0
T 23534	50 T10 - 560	56	560.0	T 23558	50 T10 - 1240	124	1240.0
T 37646	50 T10 - 600	60	600.0	T 23559	50 T10 - 1250	125	1250.0
T 23535	50 T10 - 610	61	610.0	T 23560	50 T10 - 1300	130	1300.0
T 23536	50 T10 - 630	63	630.0	T 23561	50 T10 - 1320	132	1320.0
T 23537	50 T10 - 660	66	660.0	T 23562	50 T10 - 1350	135	1350.0
T 64713	50 T10 - 680	68	680.0	T 23563	50 T10 - 1390	139	1390.0
T 23538	50 T10 - 690	69	690.0	T 23564	50 T10 - 1400	140	1400.0
T 23539	50 T10 - 700	70	700.0	T 23565	50 T10 - 1420	142	1420.0
T 23540	50 T10 - 720	72	720.0	T 23568	50 T10 - 1460	146	1460.0
T 64835	50 T10 - 730	73	730.0	T 23569	50 T10 - 1500	150	1500.0
T 23541	50 T10 - 750	75	750.0	T 23570	50 T10 - 1560	156	1560.0
T 23542	50 T10 - 780	78	780.0	T 23571	50 T10 - 1610	161	1610.0
T 23543	50 T10 - 810	81	810.0	T 23572	50 T10 - 1750	175	1750.0
T 23544	50 T10 - 840	84	840.0	T 23573	50 T10 - 1780	178	1780.0
T 23545	50 T10 - 880	88	880.0	T 23574	50 T10 - 1880	188	1880.0
T 23546	50 T10 - 890	89	890.0	T 23575	50 T10 - 1960	196	1960.0
T 23547	50 T10 - 900	90	900.0	T 23576	50 T10 - 2250	225	2250.0
T 23548	50 T10 - 920	92	920.0				

Rozmiary w mm.

### UWAGA:

Koła zębate patrz strona H 6.

# Pas zębaty T 10

Podziałka 10 mm

Materiał

Poliuretan

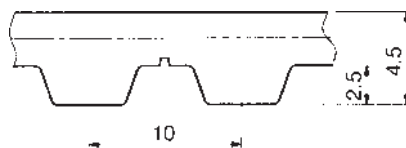

## Szerokość pasa 75 mm

Kod	Oznaczenie	Ilość zębów z	Długość mm	Kod	Oznaczenie	Ilość zębów z	Długość mm
T 23577	75 T10 - 260	26	260.0	T 23600	75 T10 - 960	96	960.0
T 41755	75 T10 - 340	34	340.0	T 23601	75 T10 - 970	97	970.0
T 23578	75 T10 - 370	37	370.0	T 23602	75 T10 - 980	98	980.0
T 23579	75 T10 - 400	40	400.0	T 23603	75 T10 - 1010	101	1010.0
T 23580	75 T10 - 410	41	410.0	T 23604	75 T10 - 1080	108	1080.0
T 23581	75 T10 - 440	44	440.0	T 23605	75 T10 - 1110	111	1110.0
T 41756	75 T10 - 480	48	480.0	T 23606	75 T10 - 1140	114	1140.0
T 23583	75 T10 - 500	50	500.0	T 23607	75 T10 - 1150	115	1150.0
T 23584	75 T10 - 530	53	530.0	T 23608	75 T10 - 1210	121	1210.0
T 23585	75 T10 - 560	56	560.0	T 23609	75 T10 - 1240	124	1240.0
T 37647	75 T10 - 600	60	600.0	T 23610	75 T10 - 1250	125	1250.0
T 23586	75 T10 - 610	61	610.0	T 23611	75 T10 - 1300	130	1300.0
T 23587	75 T10 - 630	63	630.0	T 23612	75 T10 - 1320	132	1320.0
T 23588	75 T10 - 660	66	660.0	T 23613	75 T10 - 1350	135	1350.0
T 64714	75 T10 - 680	68	680.0	T 23614	75 T10 - 1390	139	1390.0
T 23589	75 T10 - 690	69	690.0	T 23615	75 T10 - 1400	140	1400.0
T 23590	75 T10 - 700	70	700.0	T 23616	75 T10 - 1420	142	1420.0
T 23591	75 T10 - 720	72	720.0	T 23619	75 T10 - 1460	146	1460.0
T 64836	75 T10 - 730	73	730.0	T 23620	75 T10 - 1500	150	1500.0
T 23592	75 T10 - 750	75	750.0	T 23621	75 T10 - 1560	156	1560.0
T 23593	75 T10 - 780	78	780.0	T 23622	75 T10 - 1610	161	1610.0
T 23594	75 T10 - 810	81	810.0	T 23623	75 T10 - 1750	175	1750.0
T 23595	75 T10 - 840	84	840.0	T 23624	75 T10 - 1780	178	1780.0
T 23596	75 T10 - 880	88	880.0	T 23625	75 T10 - 1880	188	1880.0
T 23597	75 T10 - 890	89	890.0	T 23626	75 T10 - 1960	196	1960.0
T 23598	75 T10 - 900	90	900.0	T 23627	75 T10 - 2250	225	2250.0
T 23599	75 T10 - 920	92	920.0				

Rozmiary w mm.

### UWAGA:

Koła zębate na zapytanie.

# Pas zębaty T 10

Podziałka 10 mm

Materiał

Poliuretan

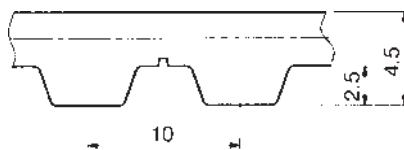

## Szerokość pasa 100 mm

Kod	Oznaczenie	Ilość zębów z	Długość mm	Kod	Oznaczenie	Ilość zębów z	Długość mm
T 23628	100 T10 - 260	26	260.0	T 23651	100 T10 - 960	96	960.0
T 41757	100 T10 - 340	34	340.0	T 23652	100 T10 - 970	97	970.0
T 23629	100 T10 - 370	37	370.0	T 23653	100 T10 - 980	98	980.0
T 23630	100 T10 - 400	40	400.0	T 23654	100 T10 - 1010	101	1010.0
T 23631	100 T10 - 410	41	410.0	T 23655	100 T10 - 1080	108	1080.0
T 23632	100 T10 - 440	44	440.0	T 23656	100 T10 - 1110	111	1110.0
T 41758	100 T10 - 480	48	480.0	T 23657	100 T10 - 1140	114	1140.0
T 23634	100 T10 - 500	50	500.0	T 23658	100 T10 - 1150	115	1150.0
T 23635	100 T10 - 530	53	530.0	T 23659	100 T10 - 1210	121	1210.0
T 23636	100 T10 - 560	56	560.0	T 23660	100 T10 - 1240	124	1240.0
T 37648	100 T10 - 600	60	600.0	T 23661	100 T10 - 1250	125	1250.0
T 23637	100 T10 - 610	61	610.0	T 23662	100 T10 - 1300	130	1300.0
T 23638	100 T10 - 630	63	630.0	T 23663	100 T10 - 1320	132	1320.0
T 23639	100 T10 - 660	66	660.0	T 23664	100 T10 - 1350	135	1350.0
T 64715	100 T10 - 680	68	680.0	T 23665	100 T10 - 1390	139	1390.0
T 23640	100 T10 - 690	69	690.0	T 23666	100 T10 - 1400	140	1400.0
T 23641	100 T10 - 700	70	700.0	T 23667	100 T10 - 1420	142	1420.0
T 23642	100 T10 - 720	72	720.0	T 23670	100 T10 - 1460	146	1460.0
T 64837	100 T10 - 730	73	730.0	T 23671	100 T10 - 1500	150	1500.0
T 23643	100 T10 - 750	75	750.0	T 23672	100 T10 - 1560	156	1560.0
T 23644	100 T10 - 780	78	780.0	T 23673	100 T10 - 1610	161	1610.0
T 23645	100 T10 - 810	81	810.0	T 23674	100 T10 - 1750	175	1750.0
T 23646	100 T10 - 840	84	840.0	T 23675	100 T10 - 1780	178	1780.0
T 23647	100 T10 - 880	88	880.0	T 23676	100 T10 - 1880	188	1880.0
T 23648	100 T10 - 890	89	890.0	T 23677	100 T10 - 1960	196	1960.0
T 23649	100 T10 - 900	90	900.0	T 23678	100 T10 - 2250	225	2250.0
T 23650	100 T10 - 920	92	920.0				

Rozmiary w mm.

### UWAGA:

Koła zębate na zapytanie.

Pas zębaty o podziałce 20 mm na zapytanie.

# Pas obustronnie zębaty DT 5

Podziałka 5 mm

Materiał

Poliuretan

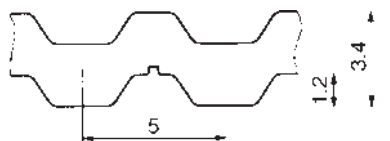

## Szerokość pasa 6 mm

Kod	Oznaczenie	Ilość zębów z	Długość mm	Kod	Oznaczenie	Ilość zębów z	Długość mm
T 28847	6 DT5 - 410	82	410	T 28859	6 DT5 - 815	163	815
T 28848	6 DT5 - 460	92	460	T 28860	6 DT5 - 860	172	860
T 28853	6 DT5 - 590	118	590	T 28861	6 DT5 - 940	188	940
T 28854	6 DT5 - 620	124	620	T 28863	6 DT5 - 1100	220	1100
T 28857	6 DT5 - 750	150	750				

## Szerokość pasa 8 mm

T 28864	8 DT5 - 410	82	410	T 28877	8 DT5 - 815	163	815
T 28865	8 DT5 - 460	92	460	T 28878	8 DT5 - 860	172	860
T 28871	8 DT5 - 590	118	590	T 28879	8 DT5 - 940	188	940
T 28872	8 DT5 - 620	124	620	T 28881	8 DT5 - 1100	220	1100
T 28875	8 DT5 - 750	150	750				

## Szerokość pasa 10 mm

T 28882	10 DT5 - 410	82	410	T 28894	10 DT5 - 815	163	815
T 28883	10 DT5 - 460	92	460	T 28895	10 DT5 - 860	172	860
T 28888	10 DT5 - 590	118	590	T 28896	10 DT5 - 940	188	940
T 28889	10 DT5 - 620	124	620	T 28898	10 DT5 - 1100	220	1100
T 28892	10 DT5 - 750	150	750				

Rozmiary w mm.

### UWAGA:

Koła zębate dla pasa o szer. 6 mm i 8 mm na zapytanie, dla pasa o szer. 10 mm patrz strona H 3.

# Pas obustronnie zębaty DT 5

Podziałka 5 mm

Materiał

Poliuretan

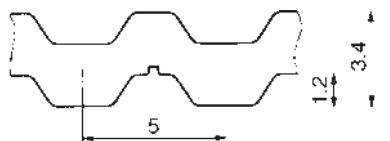

## Szerokość pasa 12 mm

Kod	Oznaczenie	Ilość zębów z	Długość mm	Kod	Oznaczenie	Ilość zębów z	Długość mm
T 28899	12 DT5 - 410	82	410	T 28911	12 DT5 - 815	163	815
T 28900	12 DT5 - 460	92	460	T 28912	12 DT5 - 860	172	860
T 28905	12 DT5 - 590	118	590	T 28913	12 DT5 - 940	188	940
T 28906	12 DT5 - 620	124	620	T 28915	12 DT5 - 1100	220	1100
T 28909	12 DT5 - 750	150	750				

## Szerokość pasa 16 mm

T 28916	16 DT5 - 410	82	410	T 28931	16 DT5 - 815	163	815
T 28917	16 DT5 - 460	92	460	T 28933	16 DT5 - 860	172	860
T 28922	16 DT5 - 590	118	590	T 28934	16 DT5 - 940	188	940
T 28923	16 DT5 - 620	124	620	T 28937	16 DT5 - 1100	220	1100
T 28926	16 DT5 - 750	150	750				

## Szerokość pasa 20 mm

T 28939	20 DT5 - 410	82	410	T 28960	20 DT5 - 815	163	815
T 28941	20 DT5 - 460	92	460	T 28962	20 DT5 - 860	172	860
T 28949	20 DT5 - 590	118	590	T 28964	20 DT5 - 940	188	940
T 28952	20 DT5 - 620	124	620	T 28968	20 DT5 - 1100	220	1100
T 28957	20 DT5 - 750	150	750				

Rozmiary w mm.

### UWAGA:

Koła zębate dla pasa o szer. 12 mm i 20 mm na zapytanie, dla pasa o szer. 16 mm patrz strona H 3 - H 4.

# Pas obustronnie zębaty DT 5

Podziałka 5 mm

Materiał

Poliuretan

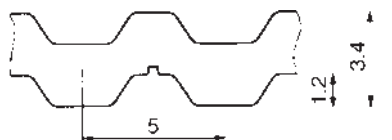

## Szerokość pasa 25 mm

Kod	Oznaczenie	Ilość zębów z	Długość mm	Kod	Oznaczenie	Ilość zębów z	Długość mm
T 28969	25 DT5 - 410	82	410	T 28985	25 DT5 - 815	163	815
T 28971	25 DT5 - 460	92	460	T 28986	25 DT5 - 860	172	860
T 28977	25 DT5 - 590	118	590	T 28987	25 DT5 - 940	188	940
T 28979	25 DT5 - 620	124	620	T 28990	25 DT5 - 1100	220	1100
T 28983	25 DT5 - 750	150	750				

## Szerokość pasa 32 mm

T 28992	32 DT5 - 410	82	410	T 29018	32 DT5 - 815	163	815
T 28996	32 DT5 - 460	92	460	T 29020	32 DT5 - 860	172	860
T 29006	32 DT5 - 590	118	590	T 29022	32 DT5 - 940	188	940
T 29008	32 DT5 - 620	124	620	T 29025	32 DT5 - 1100	220	1100
T 29015	32 DT5 - 750	150	750				

Rozmiary w mm.

### UWAGA:

Koła zębate dla pasa o szer. 25 mm patrz strona H 4, dla pasa o szer. 32 mm na zapytanie.



# Pas obustronnie zębaty DT 10

Podziałka 10 mm

Materiał

Poliuretan

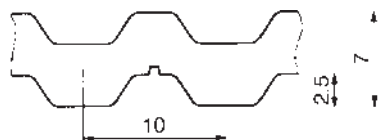

## Szerokość pasa 10 mm

Kod	Oznaczenie	Ilość zębów z	Długość mm	Kod	Oznaczenie	Ilość zębów z	Długość mm
T 28927	10 DT10 - 260	26	260	T 28956	10 DT10 - 1240	124	1240
T 28928	10 DT10 - 530	53	530	T 28958	10 DT10 - 1250	125	1250
T 28932	10 DT10 - 630	63	630	T 28961	10 DT10 - 1320	132	1320
T 28935	10 DT10 - 660	66	660	T 28963	10 DT10 - 1350	135	1350
T 28940	10 DT10 - 720	72	720	T 28965	10 DT10 - 1420	142	1420
T 28945	10 DT10 - 840	84	840	T 28970	10 DT10 - 1610	161	1610
T 28950	10 DT10 - 980	98	980	T 28978	10 DT10 - 1880	188	1880
T 28954	10 DT10 - 1210	121	1210				

## Szerokość pasa 12 mm

T 28980	12 DT10 - 260	26	260	T 29010	12 DT10 - 1240	124	1240
T 28989	12 DT10 - 530	53	530	T 29012	12 DT10 - 1250	125	1250
T 28993	12 DT10 - 630	63	630	T 29014	12 DT10 - 1320	132	1320
T 28994	12 DT10 - 660	66	660	T 29017	12 DT10 - 1350	135	1350
T 28997	12 DT10 - 720	72	720	T 29019	12 DT10 - 1420	142	1420
T 29001	12 DT10 - 840	84	840	T 29023	12 DT10 - 1610	161	1610
T 29005	12 DT10 - 980	98	980	T 29027	12 DT10 - 1880	188	1880
T 29009	12 DT10 - 1210	121	1210				

## Szerokość pasa 16 mm

T 29028	16 DT10 - 260	26	260	T 29042	16 DT10 - 1240	124	1240
T 29029	16 DT10 - 530	53	530	T 29043	16 DT10 - 1250	125	1250
T 29031	16 DT10 - 630	63	630	T 29044	16 DT10 - 1320	132	1320
T 29032	16 DT10 - 660	66	660	T 29045	16 DT10 - 1350	135	1350
T 29034	16 DT10 - 720	72	720	T 29047	16 DT10 - 1420	142	1420
T 29036	16 DT10 - 840	84	840	T 29049	16 DT10 - 1610	161	1610
T 29039	16 DT10 - 980	98	980	T 29053	16 DT10 - 1880	188	1880
T 29041	16 DT10 - 1210	121	1210				

Rozmiary w mm.

### UWAGA:

Koła zębate dla pasa o szer. 10 mm i 12 mm na zapytanie, dla pasa o szer. 16 mm patrz strona H 5.

# Pas obustronnie zębaty DT 10

Podziałka 10 mm

Materiał

Poliuretan

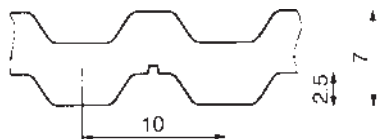

## Szerokość pasa 20 mm

Kod	Oznaczenie	Ilość zębów z	Długość mm	Kod	Oznaczenie	Ilość zębów z	Długość mm
T 29046	20 DT10 - 260	26	260	T 29064	20 DT10 - 1240	124	1240
T 29050	20 DT10 - 530	53	530	T 29065	20 DT10 - 1250	125	1250
T 29054	20 DT10 - 630	63	630	T 29066	20 DT10 - 1320	132	1320
T 29055	20 DT10 - 660	66	660	T 29067	20 DT10 - 1350	135	1350
T 29057	20 DT10 - 720	72	720	T 29068	20 DT10 - 1420	142	1420
T 29059	20 DT10 - 840	84	840	T 29070	20 DT10 - 1610	161	1610
T 29061	20 DT10 - 980	98	980	T 29072	20 DT10 - 1880	188	1880
T 29063	20 DT10 - 1210	121	1210				

## Szerokość pasa 25 mm

T 29073	25 DT10 - 260	26	260	T 29088	25 DT10 - 1240	124	1240
T 29075	25 DT10 - 530	53	530	T 29089	25 DT10 - 1250	125	1250
T 29077	25 DT10 - 630	63	630	T 29090	25 DT10 - 1320	132	1320
T 29078	25 DT10 - 660	66	660	T 29091	25 DT10 - 1350	135	1350
T 29080	25 DT10 - 720	72	720	T 29092	25 DT10 - 1420	142	1420
T 29082	25 DT10 - 840	84	840	T 29094	25 DT10 - 1610	161	1610
T 29084	25 DT10 - 980	98	980	T 29096	25 DT10 - 1880	188	1880
T 29087	25 DT10 - 1210	121	1210				

Rozmiary w mm.

### UWAGA:

Koła zębate dla pasa o szer. 20 mm na zapytanie, dla pasa o szer. 25 mm patrz strona H 5.

# Pas obustronnie zębaty DT 10

Podziałka 10 mm

Materiał

Poliuretan

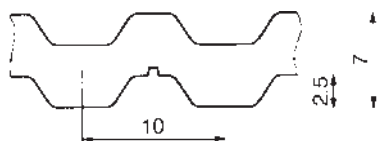

## Szerokość pasa 32 mm

Kod	Oznaczenie	Ilość zębów z	Długość mm	Kod	Oznaczenie	Ilość zębów z	Długość mm
T 29097	32 DT10 - 260	26	260	T 29110	32 DT10 - 1240	124	1240
T 29098	32 DT10 - 530	53	530	T 29111	32 DT10 - 1250	125	1250
T 29100	32 DT10 - 630	63	630	T 29112	32 DT10 - 1320	132	1320
T 29101	32 DT10 - 660	66	660	T 29113	32 DT10 - 1350	135	1350
T 29103	32 DT10 - 720	72	720	T 29114	32 DT10 - 1420	142	1420
T 29105	32 DT10 - 840	84	840	T 29116	32 DT10 - 1610	161	1610
T 29107	32 DT10 - 980	98	980	T 29118	32 DT10 - 1880	188	1880
T 29109	32 DT10 - 1210	121	1210				

## Szerokość pasa 50 mm

T 29119	50 DT10 - 260	26	260	T 29133	50 DT10 - 1240	124	1240
T 29120	50 DT10 - 530	53	530	T 29134	50 DT10 - 1250	125	1250
T 29123	50 DT10 - 630	63	630	T 29135	50 DT10 - 1320	132	1320
T 29124	50 DT10 - 660	66	660	T 29136	50 DT10 - 1350	135	1350
T 29126	50 DT10 - 720	72	720	T 29137	50 DT10 - 1420	142	1420
T 29128	50 DT10 - 840	84	840	T 29139	50 DT10 - 1610	161	1610
T 29130	50 DT10 - 980	98	980	T 29141	50 DT10 - 1880	188	1880
T 29132	50 DT10 - 1210	121	1210				

Rozmiary w mm.

### UWAGA:

Koła zębate patrz strona H 6.

# Pas zębaty AT 5

Podziałka 5 mm

Materiał

Poliuretan

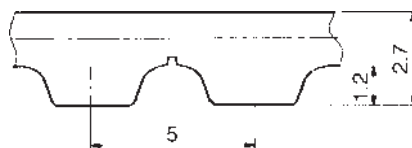

## Szerokość pasa 6 mm

Kod	Oznaczenie	Ilość zębów z	Długość mm	Kod	Oznaczenie	Ilość zębów z	Długość mm
T 41587	6 AT5 - 225	45	225	T 41613	6 AT5 - 610	122	610
T 41588	6 AT5 - 255	51	255	T 31424	6 AT5 - 660	132	660
T 41590	6 AT5 - 280	56	280	T 41614	6 AT5 - 710	142	710
T 41592	6 AT5 - 300	60	300	T 31432	6 AT5 - 750	150	750
T 41594	6 AT5 - 340	68	340	T 41615	6 AT5 - 780	156	780
T 41597	6 AT5 - 375	75	375	T 41616	6 AT5 - 825	165	825
T 41599	6 AT5 - 390	78	390	T 64726	6 AT5 - 860	172	860
T 41601	6 AT5 - 420	84	420	T 41617	6 AT5 - 975	195	975
T 49635	6 AT5 - 450	90	450	T 41618	6 AT5 - 1050	210	1050
T 41603	6 AT5 - 455	91	455	T 49651	6 AT5 - 1125	225	1125
T 31416	6 AT5 - 500	100	500	T 49659	6 AT5 - 1500	300	1500
T 41611	6 AT5 - 545	109	545	T 49675	6 AT5 - 2000	400	2000
T 41612	6 AT5 - 600	120	600				

## Szerokość pasa 8 mm

T 41619	8 AT5 - 225	45	225	T 41630	8 AT5 - 610	122	610
T 41620	8 AT5 - 255	51	255	T 31425	8 AT5 - 660	132	660
T 41621	8 AT5 - 280	56	280	T 41631	8 AT5 - 710	142	710
T 41622	8 AT5 - 300	60	300	T 31433	8 AT5 - 750	150	750
T 41623	8 AT5 - 340	68	340	T 41632	8 AT5 - 780	156	780
T 41624	8 AT5 - 375	75	375	T 41633	8 AT5 - 825	165	825
T 41625	8 AT5 - 390	78	390	T 64727	8 AT5 - 860	172	860
T 41626	8 AT5 - 420	84	420	T 41634	8 AT5 - 975	195	975
T 49636	8 AT5 - 450	90	450	T 41635	8 AT5 - 1050	210	1050
T 41627	8 AT5 - 455	91	455	T 49652	8 AT5 - 1125	225	1125
T 31417	8 AT5 - 500	100	500	T 49660	8 AT5 - 1500	300	1500
T 41628	8 AT5 - 545	109	545	T 49676	8 AT5 - 2000	400	2000
T 41629	8 AT5 - 600	120	600				

## Szerokość pasa 10 mm

T 41636	10 AT5 - 225	45	225	T 41647	10 AT5 - 610	122	610
T 41637	10 AT5 - 255	51	255	T 31426	10 AT5 - 660	132	660
T 41638	10 AT5 - 280	56	280	T 41648	10 AT5 - 710	142	710
T 41639	10 AT5 - 300	60	300	T 31434	10 AT5 - 750	150	750
T 41640	10 AT5 - 340	68	340	T 41649	10 AT5 - 780	156	780
T 41641	10 AT5 - 375	75	375	T 41650	10 AT5 - 825	165	825
T 41642	10 AT5 - 390	78	390	T 64728	10 AT5 - 860	172	860
T 41643	10 AT5 - 420	84	420	T 41651	10 AT5 - 975	195	975
T 49637	10 AT5 - 450	90	450	T 41652	10 AT5 - 1050	210	1050
T 41644	10 AT5 - 455	91	455	T 49653	10 AT5 - 1125	225	1125
T 31418	10 AT5 - 500	100	500	T 49661	10 AT5 - 1500	300	1500
T 41645	10 AT5 - 545	109	545	T 49677	10 AT5 - 2000	400	2000
T 41646	10 AT5 - 600	120	600				

Rozmiary w mm.

### UWAGA:

Koła zębate dla pasa o szer. 6 mm i 8 mm na zapytanie, dla pasa o szer. 10 mm patrz strona H 7.

# Pas zębaty AT 5

Podziałka 5 mm

Materiał

Poliuretan

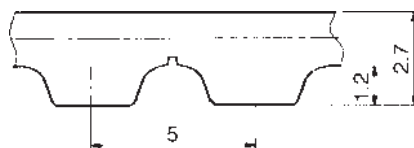

## Szerokość pasa 12 mm

Kod	Oznaczenie	Ilość zębów z	Długość mm	Kod	Oznaczenie	Ilość zębów z	Długość mm
T 41653	12 AT5 - 225	45	225	T 41668	12 AT5 - 610	122	610
T 41654	12 AT5 - 255	51	255	T 31427	12 AT5 - 660	132	660
T 41655	12 AT5 - 280	56	280	T 41670	12 AT5 - 710	142	710
T 41656	12 AT5 - 300	60	300	T 31435	12 AT5 - 750	150	750
T 41657	12 AT5 - 340	68	340	T 41673	12 AT5 - 780	156	780
T 41658	12 AT5 - 375	75	375	T 41675	12 AT5 - 825	165	825
T 41659	12 AT5 - 390	78	390	T 64729	12 AT5 - 860	172	860
T 41660	12 AT5 - 420	84	420	T 41677	12 AT5 - 975	195	975
T 49638	12 AT5 - 450	90	450	T 41681	12 AT5 - 1050	210	1050
T 41662	12 AT5 - 455	91	455	T 49654	12 AT5 - 1125	225	1125
T 31419	12 AT5 - 500	100	500	T 49662	12 AT5 - 1500	300	1500
T 41664	12 AT5 - 545	109	545	T 49678	12 AT5 - 2000	400	2000
T 41666	12 AT5 - 600	120	600				

## Szerokość pasa 16 mm

T 41682	16 AT5 - 225	45	225	T 41768	16 AT5 - 610	122	610
T 41686	16 AT5 - 255	51	255	T 31428	16 AT5 - 660	132	660
T 41689	16 AT5 - 280	56	280	T 41769	16 AT5 - 710	142	710
T 41691	16 AT5 - 300	60	300	T 31436	16 AT5 - 750	150	750
T 41761	16 AT5 - 340	68	340	T 41771	16 AT5 - 780	156	780
T 41760	16 AT5 - 375	75	375	T 41772	16 AT5 - 825	165	825
T 41762	16 AT5 - 390	78	390	T 64730	16 AT5 - 860	172	860
T 41763	16 AT5 - 420	84	420	T 41773	16 AT5 - 975	195	975
T 49639	16 AT5 - 450	90	450	T 41774	16 AT5 - 1050	210	1050
T 41764	16 AT5 - 455	91	455	T 49655	16 AT5 - 1125	225	1125
T 31420	16 AT5 - 500	100	500	T 49663	16 AT5 - 1500	300	1500
T 41766	16 AT5 - 545	109	545	T 49679	16 AT5 - 2000	400	2000
T 41767	16 AT5 - 600	120	600				

## Szerokość pasa 20 mm

T 41775	20 AT5 - 225	45	225	T 41786	20 AT5 - 610	122	610
T 41776	20 AT5 - 255	51	255	T 31429	20 AT5 - 660	132	660
T 41777	20 AT5 - 280	56	280	T 41787	20 AT5 - 710	142	710
T 41778	20 AT5 - 300	60	300	T 31437	20 AT5 - 750	150	750
T 41779	20 AT5 - 340	68	340	T 41788	20 AT5 - 780	156	780
T 41780	20 AT5 - 375	75	375	T 41789	20 AT5 - 825	165	825
T 41781	20 AT5 - 390	78	390	T 64731	20 AT5 - 860	172	860
T 41782	20 AT5 - 420	84	420	T 41790	20 AT5 - 975	195	975
T 49640	20 AT5 - 450	90	450	T 41791	20 AT5 - 1050	210	1050
T 41783	20 AT5 - 455	91	455	T 49656	20 AT5 - 1125	225	1125
T 31421	20 AT5 - 500	100	500	T 49664	20 AT5 - 1500	300	1500
T 41784	20 AT5 - 545	109	545	T 49680	20 AT5 - 2000	400	2000
T 41785	20 AT5 - 600	120	600				

Rozmiary w mm.

### UWAGA:

Koła zębate dla pasa o szer. 12 mm i 20 mm na zapytanie, dla pasa o szer. 16 mm patrz strona H 7 - H 8.

# Pas zębaty AT 5

Podziałka 5 mm

Materiał

Poliuretan

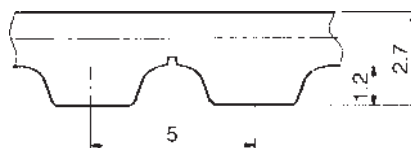

## Szerokość pasa 25 mm

Kod	Oznaczenie	Ilość zębów z	Długość mm	Kod	Oznaczenie	Ilość zębów z	Długość mm
T 41792	25 AT5 - 225	45	225	T 41815	25 AT5 - 610	122	610
T 41793	25 AT5 - 255	51	255	T 31430	25 AT5 - 660	132	660
T 41794	25 AT5 - 280	56	280	T 41816	25 AT5 - 710	142	710
T 41795	25 AT5 - 300	60	300	T 31438	25 AT5 - 750	150	750
T 41796	25 AT5 - 340	68	340	T 41817	25 AT5 - 780	156	780
T 41797	25 AT5 - 375	75	375	T 41818	25 AT5 - 825	165	825
T 41798	25 AT5 - 390	78	390	T 64732	25 AT5 - 860	172	860
T 41799	25 AT5 - 420	84	420	T 41819	25 AT5 - 975	195	975
T 49641	25 AT5 - 450	90	450	T 41820	25 AT5 - 1050	210	1050
T 41800	25 AT5 - 455	91	455	T 49657	25 AT5 - 1125	225	1125
T 31422	25 AT5 - 500	100	500	T 49665	25 AT5 - 1500	300	1500
T 41813	25 AT5 - 545	109	545	T 49681	25 AT5 - 2000	400	2000
T 41814	25 AT5 - 600	120	600				

## Szerokość pasa 32 mm

T 41821	32 AT5 - 225	45	225	T 41832	32 AT5 - 610	122	610
T 41822	32 AT5 - 255	51	255	T 31431	32 AT5 - 660	132	660
T 41823	32 AT5 - 280	56	280	T 41833	32 AT5 - 710	142	710
T 41824	32 AT5 - 300	60	300	T 31439	32 AT5 - 750	150	750
T 41825	32 AT5 - 340	68	340	T 41834	32 AT5 - 780	156	780
T 41826	32 AT5 - 375	75	375	T 41835	32 AT5 - 825	165	825
T 41827	32 AT5 - 390	78	390	T 64733	32 AT5 - 860	172	860
T 41828	32 AT5 - 420	84	420	T 41837	32 AT5 - 975	195	975
T 49642	32 AT5 - 450	90	450	T 41838	32 AT5 - 1050	210	1050
T 41829	32 AT5 - 455	91	455	T 49658	32 AT5 - 1125	225	1125
T 31423	32 AT5 - 500	100	500	T 49666	32 AT5 - 1500	300	1500
T 41830	32 AT5 - 545	109	545	T 49682	32 AT5 - 2000	400	2000
T 41831	32 AT5 - 600	120	600				

Rozmiary w mm.

### UWAGA:

Koła zębate dla pasa o szer. 25 mm patrz strona H 8, dla pasa o szer. 32 mm na zapytanie.

# Pas zębaty AT 10

Podziałka 10 mm

Materiał

Poliuretan

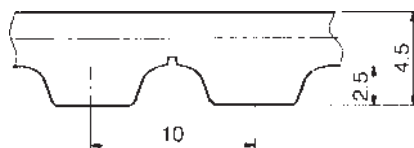

## Szerokość pasa 10 mm

Kod	Oznaczenie	Ilość zębów z	Długość mm	Kod	Oznaczenie	Ilość zębów z	Długość mm
T 41846	10 AT10 - 500	50	500	T 31503	10 AT10 - 1150	115	1150
T 41847	10 AT10 - 560	56	560	T 49544	10 AT10 - 1200	120	1200
T 41848	10 AT10 - 600	60	600	T 41863	10 AT10 - 1210	121	1210
T 41849	10 AT10 - 610	61	610	T 41864	10 AT10 - 1250	125	1250
T 31440	10 AT10 - 660	66	660	T 48275	10 AT10 - 1280	128	1280
T 41850	10 AT10 - 700	70	700	T 49552	10 AT10 - 1300	130	1300
T 41851	10 AT10 - 730	73	730	T 49560	10 AT10 - 1320	132	1320
T 31449	10 AT10 - 780	78	780	T 41865	10 AT10 - 1350	135	1350
T 41852	10 AT10 - 800	80	800	T 31513	10 AT10 - 1400	140	1400
T 31458	10 AT10 - 840	84	840	T 41866	10 AT10 - 1420	142	1420
T 41853	10 AT10 - 890	89	890	T 49621	10 AT10 - 1480	148	1480
T 31467	10 AT10 - 920	92	920	T 49576	10 AT10 - 1500	150	1500
T 31476	10 AT10 - 960	96	960	T 31522	10 AT10 - 1600	160	1600
T 41860	10 AT10 - 980	98	980	T 49584	10 AT10 - 1700	170	1700
T 31485	10 AT10 - 1000	100	1000	T 49592	10 AT10 - 1720	172	1720
T 41861	10 AT10 - 1010	101	1010	T 31531	10 AT10 - 1800	180	1800
T 49537	10 AT10 - 1050	105	1050	T 49601	10 AT10 - 1860	186	1860
T 31494	10 AT10 - 1080	108	1080	T 49611	10 AT10 - 1940	194	1940
T 41862	10 AT10 - 1100	110	1100				

## Szerokość pasa 12 mm

T 41867	12 AT10 - 500	50	500	T 31504	12 AT10 - 1150	115	1150
T 41868	12 AT10 - 560	56	560	T 49545	12 AT10 - 1200	120	1200
T 41869	12 AT10 - 600	60	600	T 41878	12 AT10 - 1210	121	1210
T 41870	12 AT10 - 610	61	610	T 41879	12 AT10 - 1250	125	1250
T 31441	12 AT10 - 660	66	660	T 48276	12 AT10 - 1280	128	1280
T 41871	12 AT10 - 700	70	700	T 49553	12 AT10 - 1300	130	1300
T 41872	12 AT10 - 730	73	730	T 49561	12 AT10 - 1320	132	1320
T 31450	12 AT10 - 780	78	780	T 41880	12 AT10 - 1350	135	1350
T 41873	12 AT10 - 800	80	800	T 31514	12 AT10 - 1400	140	1400
T 31459	12 AT10 - 840	84	840	T 41881	12 AT10 - 1420	142	1420
T 41874	12 AT10 - 890	89	890	T 49622	12 AT10 - 1480	148	1480
T 31468	12 AT10 - 920	92	920	T 49577	12 AT10 - 1500	150	1500
T 31477	12 AT10 - 960	96	960	T 31523	12 AT10 - 1600	160	1600
T 41875	12 AT10 - 980	98	980	T 49585	12 AT10 - 1700	170	1700
T 31486	12 AT10 - 1000	100	1000	T 49593	12 AT10 - 1720	172	1720
T 41876	12 AT10 - 1010	101	1010	T 31532	12 AT10 - 1800	180	1800
T 49538	12 AT10 - 1050	105	1050	T 49602	12 AT10 - 1860	186	1860
T 31495	12 AT10 - 1080	108	1080	T 49614	12 AT10 - 1940	194	1940
T 41877	12 AT10 - 1100	110	1100				

Rozmiary w mm.

### UWAGA:

Koła zębate na zapytanie.

# Pas zębaty AT 10

Podział 10 mm

Materiał

Poliuretan

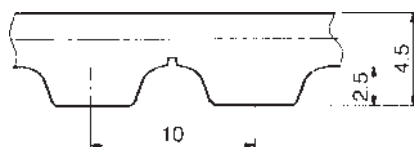

## Szerokość pasa 16 mm

Kod	Oznaczenie	Ilość zębów z	Długość mm	Kod	Oznaczenie	Ilość zębów z	Długość mm
T 41882	16 AT10 - 500	50	500	T 31505	16 AT10 - 1150	115	1150
T 41883	16 AT10 - 560	56	560	T 49546	16 AT10 - 1200	120	1200
T 41884	16 AT10 - 600	60	600	T 41893	16 AT10 - 1210	121	1210
T 41885	16 AT10 - 610	61	610	T 41894	16 AT10 - 1250	125	1250
T 31442	16 AT10 - 660	66	660	T 48277	16 AT10 - 1280	128	1280
T 41886	16 AT10 - 700	70	700	T 49554	16 AT10 - 1300	130	1300
T 41887	16 AT10 - 730	73	730	T 49562	16 AT10 - 1320	132	1320
T 31451	16 AT10 - 780	78	780	T 41895	16 AT10 - 1350	135	1350
T 41888	16 AT10 - 800	80	800	T 31515	16 AT10 - 1400	140	1400
T 31460	16 AT10 - 840	84	840	T 41896	16 AT10 - 1420	142	1420
T 41889	16 AT10 - 890	89	890	T 49623	16 AT10 - 1480	148	1480
T 31469	16 AT10 - 920	92	920	T 49578	16 AT10 - 1500	150	1500
T 31478	16 AT10 - 960	96	960	T 31524	16 AT10 - 1600	160	1600
T 41890	16 AT10 - 980	98	980	T 49586	16 AT10 - 1700	170	1700
T 31487	16 AT10 - 1000	100	1000	T 49594	16 AT10 - 1720	172	1720
T 41891	16 AT10 - 1010	101	1010	T 31533	16 AT10 - 1800	180	1800
T 49539	16 AT10 - 1050	105	1050	T 49603	16 AT10 - 1860	186	1860
T 31496	16 AT10 - 1080	108	1080	T 49615	16 AT10 - 1940	194	1940
T 41892	16 AT10 - 1100	110	1100				

## Szerokość pasa 20 mm

T 41897	20 AT10 - 500	50	500	T 31507	20 AT10 - 1150	115	1150
T 41898	20 AT10 - 560	56	560	T 49547	20 AT10 - 1200	120	1200
T 41899	20 AT10 - 600	60	600	T 41908	20 AT10 - 1210	121	1210
T 41900	20 AT10 - 610	61	610	T 41909	20 AT10 - 1250	125	1250
T 31443	20 AT10 - 660	66	660	T 48278	20 AT10 - 1280	128	1280
T 41901	20 AT10 - 700	70	700	T 49555	20 AT10 - 1300	130	1300
T 41902	20 AT10 - 730	73	730	T 49563	20 AT10 - 1320	132	1320
T 31452	20 AT10 - 780	78	780	T 41910	20 AT10 - 1350	135	1350
T 41903	20 AT10 - 800	80	800	T 31516	20 AT10 - 1400	140	1400
T 31461	20 AT10 - 840	84	840	T 41911	20 AT10 - 1420	142	1420
T 41904	20 AT10 - 890	89	890	T 49624	20 AT10 - 1480	148	1480
T 31470	20 AT10 - 920	92	920	T 49579	20 AT10 - 1500	150	1500
T 31479	20 AT10 - 960	96	960	T 31525	20 AT10 - 1600	160	1600
T 41905	20 AT10 - 980	98	980	T 49587	20 AT10 - 1700	170	1700
T 31488	20 AT10 - 1000	100	1000	T 49596	20 AT10 - 1720	172	1720
T 41906	20 AT10 - 1010	101	1010	T 31534	20 AT10 - 1800	180	1800
T 49540	20 AT10 - 1050	105	1050	T 49604	20 AT10 - 1860	186	1860
T 31497	20 AT10 - 1080	108	1080	T 49616	20 AT10 - 1940	194	1940
T 41907	20 AT10 - 1100	110	1100				

Rozmiary w mm.

### UWAGA:

Koła zębate dla pasa o szer. 16 mm patrz strona H 9, dla pasa o szer. 20 mm na zapytanie.



# Pas zębaty AT 10

Podziałka 10 mm

Materiał

Poliuretan

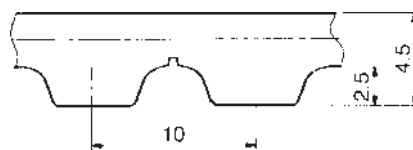

## Szerokość pasa 25 mm

Kod	Oznaczenie	Ilość zębów z	Długość mm	Kod	Oznaczenie	Ilość zębów z	Długość mm
T 41914	25 AT10 - 500	50	500	T 31508	25 AT10 - 1150	115	1150
T 41915	25 AT10 - 560	56	560	T 49548	25 AT10 - 1200	120	1200
T 41916	25 AT10 - 600	60	600	T 41926	25 AT10 - 1210	121	1210
T 41917	25 AT10 - 610	61	610	T 41927	25 AT10 - 1250	125	1250
T 31444	25 AT10 - 660	66	660	T 48279	25 AT10 - 1280	128	1280
T 41918	25 AT10 - 700	70	700	T 49556	25 AT10 - 1300	130	1300
T 41919	25 AT10 - 730	73	730	T 49564	25 AT10 - 1320	132	1320
T 31453	25 AT10 - 780	78	780	T 41928	25 AT10 - 1350	135	1350
T 41920	25 AT10 - 800	80	800	T 31517	25 AT10 - 1400	140	1400
T 31462	25 AT10 - 840	84	840	T 41929	25 AT10 - 1420	142	1420
T 41921	25 AT10 - 890	89	890	T 49625	25 AT10 - 1480	148	1480
T 31471	25 AT10 - 920	92	920	T 49580	25 AT10 - 1500	150	1500
T 31480	25 AT10 - 960	96	960	T 31526	25 AT10 - 1600	160	1600
T 41923	25 AT10 - 980	98	980	T 49588	25 AT10 - 1700	170	1700
T 31489	25 AT10 - 1000	100	1000	T 49597	25 AT10 - 1720	172	1720
T 41924	25 AT10 - 1010	101	1010	T 31535	25 AT10 - 1800	180	1800
T 60057	25 AT10 - 1050	105	1050	T 49607	25 AT10 - 1860	186	1860
T 31498	25 AT10 - 1080	108	1080	T 49617	25 AT10 - 1940	194	1940
T 41925	25 AT10 - 1100	110	1100				

## Szerokość pasa 32 mm

T 41930	32 AT10 - 500	50	500	T 31509	32 AT10 - 1150	115	1150
T 41931	32 AT10 - 560	56	560	T 49549	32 AT10 - 1200	120	1200
T 41932	32 AT10 - 600	60	600	T 41941	32 AT10 - 1210	121	1210
T 41933	32 AT10 - 610	61	610	T 41942	32 AT10 - 1250	125	1250
T 31445	32 AT10 - 660	66	660	T 48280	32 AT10 - 1280	128	1280
T 41934	32 AT10 - 700	70	700	T 49557	32 AT10 - 1300	130	1300
T 41935	32 AT10 - 730	73	730	T 49565	32 AT10 - 1320	132	1320
T 31454	32 AT10 - 780	78	780	T 41943	32 AT10 - 1350	135	1350
T 41936	32 AT10 - 800	80	800	T 31518	32 AT10 - 1400	140	1400
T 31463	32 AT10 - 840	84	840	T 41944	32 AT10 - 1420	142	1420
T 41937	32 AT10 - 890	89	890	T 49626	32 AT10 - 1480	148	1480
T 31472	32 AT10 - 920	92	920	T 49581	32 AT10 - 1500	150	1500
T 31481	32 AT10 - 960	96	960	T 31527	32 AT10 - 1600	160	1600
T 41938	32 AT10 - 980	98	980	T 49589	32 AT10 - 1700	170	1700
T 31490	32 AT10 - 1000	100	1000	T 49598	32 AT10 - 1720	172	1720
T 41939	32 AT10 - 1010	101	1010	T 31536	32 AT10 - 1800	180	1800
T 49541	32 AT10 - 1050	105	1050	T 49608	32 AT10 - 1860	186	1860
T 31499	32 AT10 - 1080	108	1080	T 49618	32 AT10 - 1940	194	1940
T 41940	32 AT10 - 1100	110	1100				

Rozmiary w mm.

### UWAGA:

Koła zębate patrz strona H 9 - H 10.

# Pas zębaty AT 10

Podziałka 10 mm

Materiał

Poliuretan

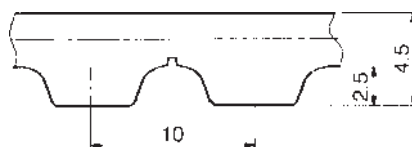

## Szerokość pasa 50 mm

Kod	Oznaczenie	Ilość zębów z	Długość mm	Kod	Oznaczenie	Ilość zębów z	Długość mm
T 41945	50 AT10 - 500	50	500	T 31510	50 AT10 - 1150	115	1150
T 41946	50 AT10 - 560	56	560	T 49550	50 AT10 - 1200	120	1200
T 41947	50 AT10 - 600	60	600	T 41960	50 AT10 - 1210	121	1210
T 41948	50 AT10 - 610	61	610	T 41961	50 AT10 - 1250	125	1250
T 31446	50 AT10 - 660	66	660	T 48281	50 AT10 - 1280	128	1280
T 41950	50 AT10 - 700	70	700	T 49558	50 AT10 - 1300	130	1300
T 41951	50 AT10 - 730	73	730	T 49566	50 AT10 - 1320	132	1320
T 31455	50 AT10 - 780	78	780	T 41962	50 AT10 - 1350	135	1350
T 41953	50 AT10 - 800	80	800	T 31519	50 AT10 - 1400	140	1400
T 31464	50 AT10 - 840	84	840	T 41963	50 AT10 - 1420	142	1420
T 41954	50 AT10 - 890	89	890	T 49627	50 AT10 - 1480	148	1480
T 31473	50 AT10 - 920	92	920	T 49582	50 AT10 - 1500	150	1500
T 31482	50 AT10 - 960	96	960	T 31528	50 AT10 - 1600	160	1600
T 41956	50 AT10 - 980	98	980	T 49590	50 AT10 - 1700	170	1700
T 31491	50 AT10 - 1000	100	1000	T 49599	50 AT10 - 1720	172	1720
T 41957	50 AT10 - 1010	101	1010	T 31537	50 AT10 - 1800	180	1800
T 49542	50 AT10 - 1050	105	1050	T 49609	50 AT10 - 1860	186	1860
T 31500	50 AT10 - 1080	108	1080	T 49619	50 AT10 - 1940	194	1940
T 41959	50 AT10 - 1100	110	1100				

## Szerokość pasa 75 mm

T 41964	75 AT10 - 500	50	500	T 31511	75 AT10 - 1150	115	1150
T 41965	75 AT10 - 560	56	560	T 49551	75 AT10 - 1200	120	1200
T 41966	75 AT10 - 600	60	600	T 41975	75 AT10 - 1210	121	1210
T 41967	75 AT10 - 610	61	610	T 41976	75 AT10 - 1250	125	1250
T 31447	75 AT10 - 660	66	660	T 48282	75 AT10 - 1280	128	1280
T 41968	75 AT10 - 700	70	700	T 49559	75 AT10 - 1300	130	1300
T 41969	75 AT10 - 730	73	730	T 65092	75 AT10 - 1320	132	1320
T 31456	75 AT10 - 780	78	780	T 41977	75 AT10 - 1350	135	1350
T 41970	75 AT10 - 800	80	800	T 31520	75 AT10 - 1400	140	1400
T 31465	75 AT10 - 840	84	840	T 41978	75 AT10 - 1420	142	1420
T 41971	75 AT10 - 890	89	890	T 49628	75 AT10 - 1480	148	1480
T 31474	75 AT10 - 920	92	920	T 49583	75 AT10 - 1500	150	1500
T 31483	75 AT10 - 960	96	960	T 31529	75 AT10 - 1600	160	1600
T 41972	75 AT10 - 980	98	980	T 49591	75 AT10 - 1700	170	1700
T 31492	75 AT10 - 1000	100	1000	T 49600	75 AT10 - 1720	172	1720
T 41973	75 AT10 - 1010	101	1010	T 31538	75 AT10 - 1800	180	1800
T 49543	75 AT10 - 1050	105	1050	T 49610	75 AT10 - 1860	186	1860
T 31501	75 AT10 - 1080	108	1080	T 49620	75 AT10 - 1940	194	1940
T 41974	75 AT10 - 1100	110	1100				

Rozmiary w mm.

### UWAGA:

Koła zębate dla pasa o szer. 50 mm patrz strona H 10, dla pasa o szer. 75 mm na zapytanie.

# Pas zębaty AT 10

Podziałka 10 mm

Materiał

Poliuretan

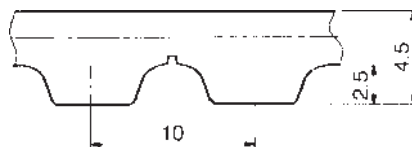

## Szerokość pasa 100 mm

Kod	Oznaczenie	Ilość zębów z	Długość mm	Kod	Oznaczenie	Ilość zębów z	Długość mm
T 41979	100 AT10 - 500	50	500	T 31512	100 AT10 - 1150	115	1150
T 41980	100 AT10 - 560	56	560	T 65094	100 AT10 - 1200	120	1200
T 41981	100 AT10 - 600	60	600	T 41992	100 AT10 - 1210	121	1210
T 41982	100 AT10 - 610	61	610	T 41993	100 AT10 - 1250	125	1250
T 31448	100 AT10 - 660	66	660	T 48283	100 AT10 - 1280	128	1280
T 41983	100 AT10 - 700	70	700	T 65095	100 AT10 - 1300	130	1300
T 41984	100 AT10 - 730	73	730	T 65096	100 AT10 - 1320	132	1320
T 31457	100 AT10 - 780	78	780	T 41994	100 AT10 - 1350	135	1350
T 41985	100 AT10 - 800	80	800	T 31521	100 AT10 - 1400	140	1400
T 31466	100 AT10 - 840	84	840	T 41996	100 AT10 - 1420	142	1420
T 41986	100 AT10 - 890	89	890	T 65097	100 AT10 - 1480	148	1480
T 31475	100 AT10 - 920	92	920	T 65098	100 AT10 - 1500	150	1500
T 31484	100 AT10 - 960	96	960	T 31530	100 AT10 - 1600	160	1600
T 41989	100 AT10 - 980	98	980	T 65099	100 AT10 - 1700	170	1700
T 31493	100 AT10 - 1000	100	1000	T 65100	100 AT10 - 1720	172	1720
T 41990	100 AT10 - 1010	101	1010	T 31539	100 AT10 - 1800	180	1800
T 65093	100 AT10 - 1050	105	1050	T 65101	100 AT10 - 1860	186	1860
T 31502	100 AT10 - 1080	108	1080	T 65102	100 AT10 - 1940	194	1940
T 41991	100 AT10 - 1100	110	1100				

Rozmiary w mm.

### **UWAGA:**

Koła zębate na zapytanie.

# Pas zębaty bezkońcowy

Material

Poliuretan

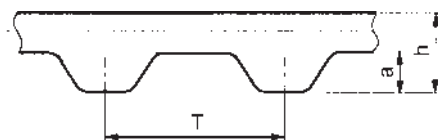

Kod	Typ	Podziałka T	h	a	Standardowe szerokości
Na zapytanie	XL	5.080	2.3	1.27	6.35 / 9.39 / 12.7 / 19.1 / 25.4 / 38.1 / 50.8 / 76.2 / 101.6 / 152.4
	L	9.525	3.6	1.90	9.39 / 12.7 / 19.1 / 25.4 / 38.1 / 50.8 / 76.2 / 101.6 / 152.4
	H	12.7	4.3	2.29	12.7 / 19.1 / 25.4 / 38.1 / 50.8 / 76.2 / 101.6 / 152.4
	XH	22.225	11.2	6.35	19.1 / 25.4 / 38.1 / 50.8 / 76.2 / 101.6 / 152.4



Kod	Typ	Podziałka T	h	a	Standardowe szerokości
Na zapytanie	T 5	5	2.2	1.20	6 / 10 / 12 / 16 / 25 / 32 / 50 / 75 / 100 / 150
	T10	10	4.5	2.50	12 / 16 / 25 / 32 / 50 / 75 / 100 / 150
	T20	20	8.0	5.00	25 / 32 / 50 / 75 / 100 / 150
	AT 5	5	2.7	1.20	6 / 10 / 12 / 16 / 25 / 32 / 50 / 75 / 100 / 150
	AT10	10	4.5	2.50	12 / 16 / 25 / 32 / 50 / 75 / 100 / 150
	AT20	20	8.0	5.00	25 / 32 / 50 / 75 / 100 / 150

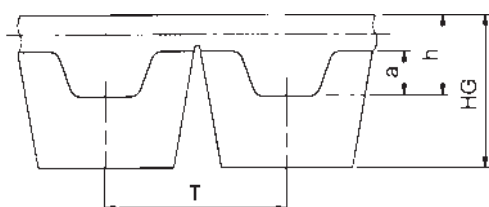

Kod	Typ	Podziałka T	h	a	HG	Standardowe szerokości
Na zapytanie	ATG 10	10	4.5	2.50	8.3	16 / 20 / 25 / 32 / 50 / 75 / 85 / 100 / 150

Rozmiary w mm.

**Pas zębaty bezkońcowy można dostarczyć w długościach od 1500 do 19500 mm.**

### UWAGA:

Pasy zębate bezkońcowe produkuje się z termoplastycznego poliuretanu shore 92°, który cechuje się wysoką twardością i odpornością na zużycie. Pasy te, mogą mieć także specjalne powierzchniowe warstwy od strony grzbietu patrz strona G 48.

Wysoka wytrzymałość stalowego włókna, umożliwia osiągnięcie wysokich sił na zerwanie przy krótkich odległościach. Włókna stalowe dostarczane są w standardowym wykonaniu. Pasy z innymi specjalnymi włóknami dostarcza się na zapytanie.

# Pas zębaty bezkońcowy

Materiał

Poliuretan

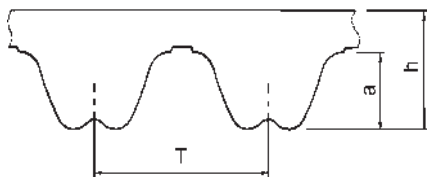

Kod	Typ	Podział. mm	h	a	Standardowe szerokości
Na zapytanie	RPP 5	5	3.8	2.00	10 / 16 / 20 / 25 / 32 / 50 / 85 / 100 / 150
	RPP 8	8	5.4	3.20	10 / 16 / 20 / 25 / 32 / 50 / 85 / 100 / 150
	RPP14	14	10.0	6.00	16 / 20 / 25 / 32 / 50 / 85 / 100 / 150

Rozmiary w mm.

**Pasy zębate bezkońcowe RPP są dostępne w długościach od 1900 do 19500 mm.**

### **UWAGA:**

Pasy zębate bezkońcowe produkowane są z termoplastycznego poliuretanu o twardości 92° shore, które charakteryzują się dużą twardością oraz odpornością zębów na ścieranie. Powyższe pasy mogą mieć różne pokrycia strony zewnętrznej. Dzięki zastosowaniu stalowych włókien uzyskano bardzo wysoką wytrzymałość.

Wysoka wytrzymałość stalowego włókna, umożliwia osiągnięcie wysokich sił na zerwanie przy krótkich odległościach. Włókna stalowe dostarczane są w standardowym wykonaniu. Pasy z innymi specjalnymi włóknami dostarcza się na zapytanie.

### **Specjalne wykonanie:**

- wysoce elastyczne włókna stalowe
- nylonowa tkanina ze strony zębów (NFT)
- specjalne wykonania: frezowanie, szlifowanie
- specjalne pokrycia pasa - patrz strona G 48.

# Pas zębaty - w metrażu

otwarty lub zamknięty

Materiał

Poliuretan

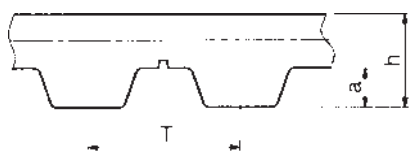

Profil T

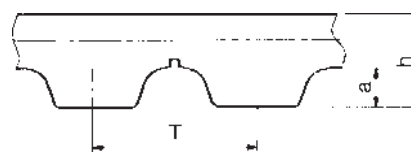

Profil AT

## Kord stalowy

Metraż	Zamknięty		Podział.			
Kod	Kod	Typ	T	Szer.	h	a
T 31360	-	T 5	5	6	2.2	1.2
T 31361	-	T 5	5	8	2.2	1.2
T 31362	T 31542	T 5	5	10	2.2	1.2
T 31363	T 31543	T 5	5	16	2.2	1.2
T 31364	-	T 5	5	20	2.2	1.2
T 31365	T 31545	T 5	5	25	2.2	1.2
T 31366	T 31546	T 5	5	32	2.2	1.2
T 31367	T 31547	T 5	5	50	2.2	1.2
T 79903	-	T 5	5	75	2.2	1.2
T 79904	-	T 5	5	100	2.2	1.2
T 31368	-	T 10	10	12	4.5	2.5
T 31369	T 31549	T 10	10	16	4.5	2.5
T 31371	T 31552	T 10	10	25	4.5	2.5
T 31373	T 31554	T 10	10	32	4.5	2.5
T 31375	T 31556	T 10	10	50	4.5	2.5
T 31376	-	T 10	10	75	4.5	2.5
T 31377	-	T 10	10	100	4.5	2.5
T 79905	-	T 10	10	150	4.5	2.5
T 31378	-	T 20	20	25	8.0	5.0
T 31379	-	T 20	20	32	8.0	5.0
T 31380	-	T 20	20	50	8.0	5.0
T 31381	-	T 20	20	75	8.0	5.0
T 31382	-	T 20	20	100	8.0	5.0
T 79906	-	T 20	20	125	8.0	5.0
T 79907	-	T 20	20	150	8.0	5.0

## Kord stalowy

Metraż	Zamknięty		Podział.			
Kod	Kod	Typ	T	Szer.	h	a
T 31383	-	AT 5	5	6	2.7	1.2
T 31384	-	AT 5	5	10	2.7	1.2
T 31385	-	AT 5	5	16	2.7	1.2
T 31387	-	AT 5	5	25	2.7	1.2
T 31388	-	AT 5	5	32	2.7	1.2
T 31389	-	AT 5	5	50	2.7	1.2
T 79908	-	AT 5	5	75	2.7	1.2
T 79909	-	AT 5	5	100	2.7	1.2
T 31390	-	AT 10	10	16	4.5	2.5
T 31391	-	AT 10	10	25	4.5	2.5
T 31392	-	AT 10	10	32	4.5	2.5
T 31394	-	AT 10	10	50	4.5	2.5
T 31395	-	AT 10	10	75	4.5	2.5
T 31396	-	AT 10	10	100	4.5	2.5
T 79913	-	AT 10	10	150	4.5	2.5
T 31397	-	AT 20	20	25	8.0	5.0
T 31398	-	AT 20	20	32	8.0	5.0
T 31399	-	AT 20	20	50	8.0	5.0
T 31400	-	AT 20	20	75	8.0	5.0
T 31401	-	AT 20	20	100	8.0	5.0
T 79914	-	AT 20	20	150	8.0	5.0
T 79915	-	AT 20	20	200	8.0	5.0

Rozmiary w mm.

### UWAGA:

Minimalna długość dla pasów zębatach zamkniętych od 900 mm.

Specjalne pokrycia - patrz strona G 48.

Płytki mocujące dla pasów zębatach patrz strona H 53.

# Pas zębaty - w metrażu

otwarty lub zamknięty

Materiał

Poliuretan



Profil XL, L, H

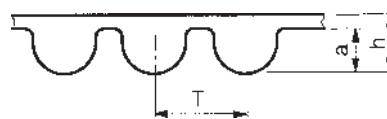

Profil HTD

## Kord stalowy

Metraż	Typ	Podział. T	Szer. kod / mm	h	a
Kod					
T 31341	XL	5.08	025/ 6.35	2.3	1.27
T 31342	XL	5.08	031/ 7.87	2.3	1.27
T 31343	XL	5.08	037/ 9.53	2.3	1.27
T 31344	XL	5.08	050/ 12.70	2.3	1.27
T 31345	XL	5.08	075/ 19.05	2.3	1.27
T 31346	XL	5.08	100/ 25.40	2.3	1.27
T 79910	XL	5.08	150/ 38.10	2.3	1.27
T 79911	XL	5.08	200/ 50.80	2.3	1.27
T 31347	L	9.52	037/ 9.53	3.6	1.90
T 31348	L	9.52	050/ 12.70	3.6	1.90
T 31349	L	9.52	075/ 19.05	3.6	1.90
T 31350	L	9.52	100/ 25.40	3.6	1.90
T 31351	L	9.52	150/ 38.10	3.6	1.90
T 31352	L	9.52	200/ 50.80	3.6	1.90
T 31353	H	12.70	050/ 12.70	4.3	2.29
T 31354	H	12.70	075/ 19.05	4.3	2.29
T 31355	H	12.70	100/ 25.40	4.3	2.29
T 31356	H	12.70	150/ 38.10	4.3	2.29
T 31357	H	12.70	200/ 50.80	4.3	2.29
T 31358	H	12.70	300/ 76.20	4.3	2.29
T 31359	H	12.70	400/101.60	4.3	2.29

## Kord stalowy

Metraż	Typ	Podział. T	Szer.	h	a
Kod					
T 31325	5M	5	10	3.6	2.1
T 31326	5M	5	15	3.6	2.1
T 31327	5M	5	25	3.6	2.1
T 31328	5M	5	50	3.6	2.1
T 31329	8M	8	10	5.6	3.4
T 31330	8M	8	15	5.6	3.4
T 31331	8M	8	20	5.6	3.4
T 31332	8M	8	30	5.6	3.4
T 31333	8M	8	50	5.6	3.4
T 31334	8M	8	85	5.6	3.4
T 31335	8M	8	100	5.6	3.4
T 31336	14M	14	25	10.0	6.1
T 31337	14M	14	40	10.0	6.1
T 31338	14M	14	55	10.0	6.1
T 31339	14M	14	85	10.0	6.1
T 31340	14M	14	100	10.0	6.1
T 79912	14M	14	115	10.0	6.1

# Pas zębaty - w metrażu

otwarty lub zamknięty

Materiał

Poliuretan

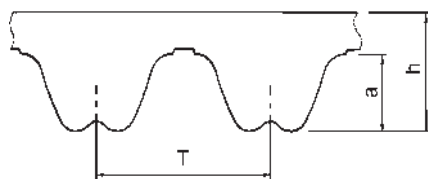

Profil RPP

## Kord stalowy / nylonowa tkanina od strony zębów (NFT)

Metraż	Typ	Podział. T	Szer.	h	a	Metraż	Typ	Podział. T	Szer.	h	a
Kod						Kod					
T 65804	RPP 5	5	10	3.8	2.0	T 65810	RPP 8	8	30	5.4	3.2
T 65806	RPP 5	5	15	3.8	2.0	T 65811	RPP 8	8	50	5.4	3.2
T 65807	RPP 5	5	25	3.8	2.0	T 65812	RPP 8	8	85	5.4	3.2
T 78090	RPP 5	5	30	3.8	2.0	T 65813	RPP 8	8	100	5.4	3.2
T 65808	RPP 5	5	50	3.8	2.0	T 65814	RPP14	14	40	10.0	6.0
T 78091	RPP 8	8	10	5.4	3.2	T 65815	RPP14	14	55	10.0	6.0
T 78092	RPP 8	8	15	5.4	3.2	T 65816	RPP14	14	85	10.0	6.0
T 65809	RPP 8	8	20	5.4	3.2	T 65817	RPP14	14	115	10.0	6.0

Rozmiary w mm.